

# **Full Line Brochure**

(RESGN100)

Updated: 1/17



*Quality You Can Trust...From  
North America's Largest Roofing Manufacturer!™*



# RESIDENTIAL ROOFING GUIDE

The One-Stop Guide To North America's #1-Selling Roofing Products

*gaf.com*

Find Your Color

Find Your Style

Protect What You Value Most

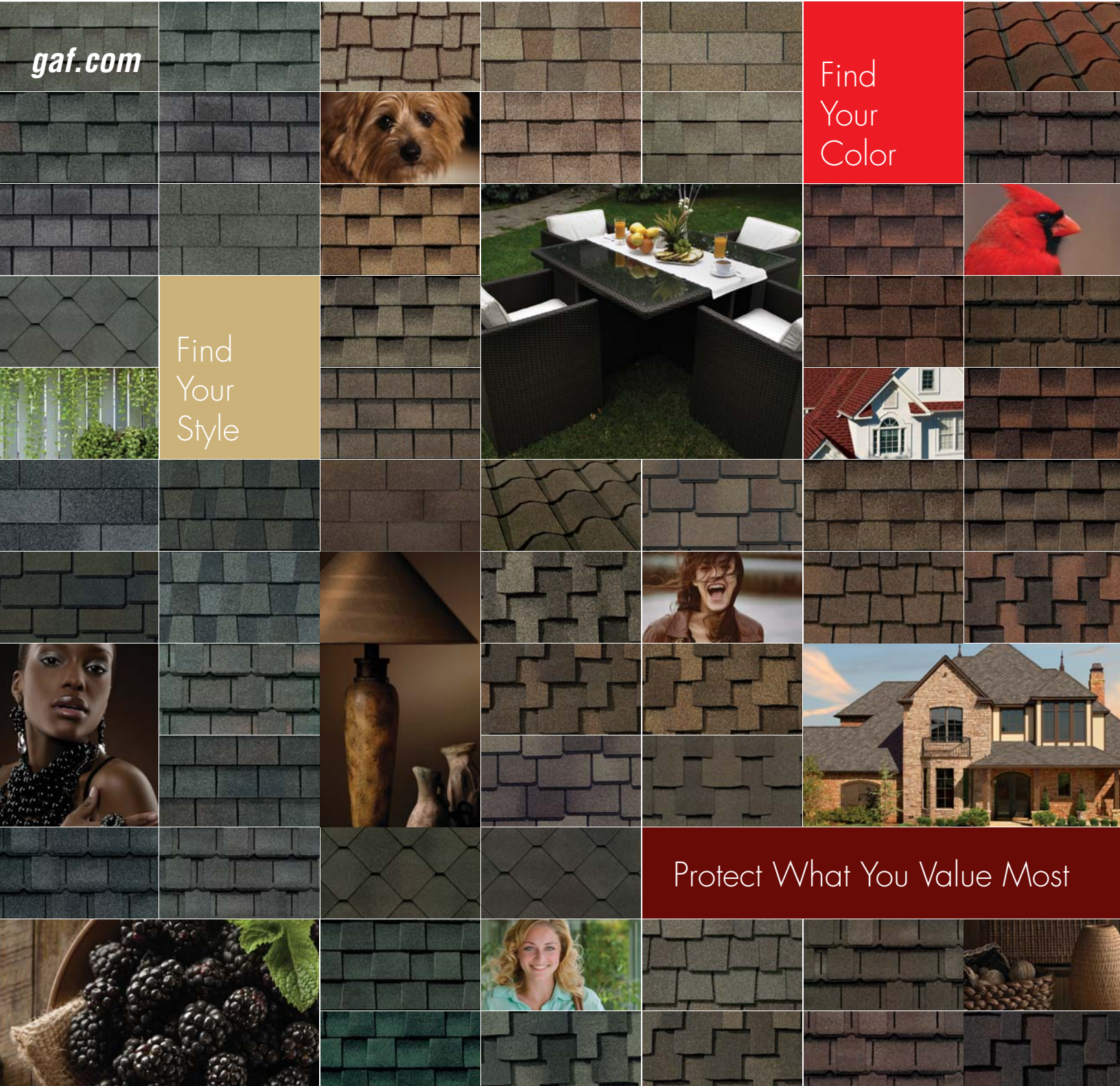



## GAF Lifetime<sup>†</sup> Roofing System 2-45

Timberline <sup>®</sup> Lifetime Shingles	6-21
Timberline <sup>®</sup> Ultra HD <sup>®</sup>	10
Timberline <sup>®</sup> HD <sup>®</sup>	12
Timberline <sup>®</sup> American Harvest <sup>®</sup>	16
Timberline <sup>®</sup> Natural Shadow <sup>®</sup>	18
Timberline <sup>®</sup> Cool Series <sup>®</sup>	20
Lifetime Designer Shingles	22-35
Ultra-Premium Collection	
Glenwood <sup>®</sup>	24
Camelot <sup>®</sup>	26
Grand Canyon <sup>®</sup>	28
Value Collection	30-35
Sienna <sup>®</sup>	30
Woodland <sup>®</sup>	30
Monaco <sup>®</sup>	32
Camelot <sup>®</sup> II	32
Grand Sequoia <sup>®</sup>	34
Slateline <sup>®</sup>	34
SBS Modified IR Shingles	36-37
Grand Sequoia <sup>®</sup> ArmorShield™	36
Timberline <sup>®</sup> ArmorShield™ II	36
Lifetime Roofing System Accessories	38-45
Ridge Cap Shingles	38
Roof Deck Protection	40
Leak Barriers	42
Eave/Rake Starter Strips	43
Cobra <sup>®</sup> Attic Ventilation	44

## Other GAF Roofing Products 46-53

Three-Tab Shingles	46
Master Flow <sup>®</sup> Ventilation Products	48
LIBERTY™ Low-Slope Roofing	48
WeatherSide™ Fiber-Cement Siding	49
ShingleMatch™ Accessory Paint	49
Shingle Specifications	50
TruSlate <sup>®</sup> Genuine Slate Roofing	52
Color And Style	54
GAF Timeline	58

# THE GAF LIFETIME<sup>†</sup> ROOFING SYSTEM

*Because There's More To A Roof Than Just Shingles*

## GET AUTOMATIC LIFETIME PROTECTION ON YOUR ENTIRE GAF ROOFING SYSTEM!<sup>†</sup>

A new roof is more than just shingles. When you install any GAF Lifetime Shingle and at least 3 qualifying GAF accessories, you'll automatically get a Lifetime Ltd. warranty on your shingles and all qualifying GAF accessories.<sup>†</sup> Why settle for anything less?

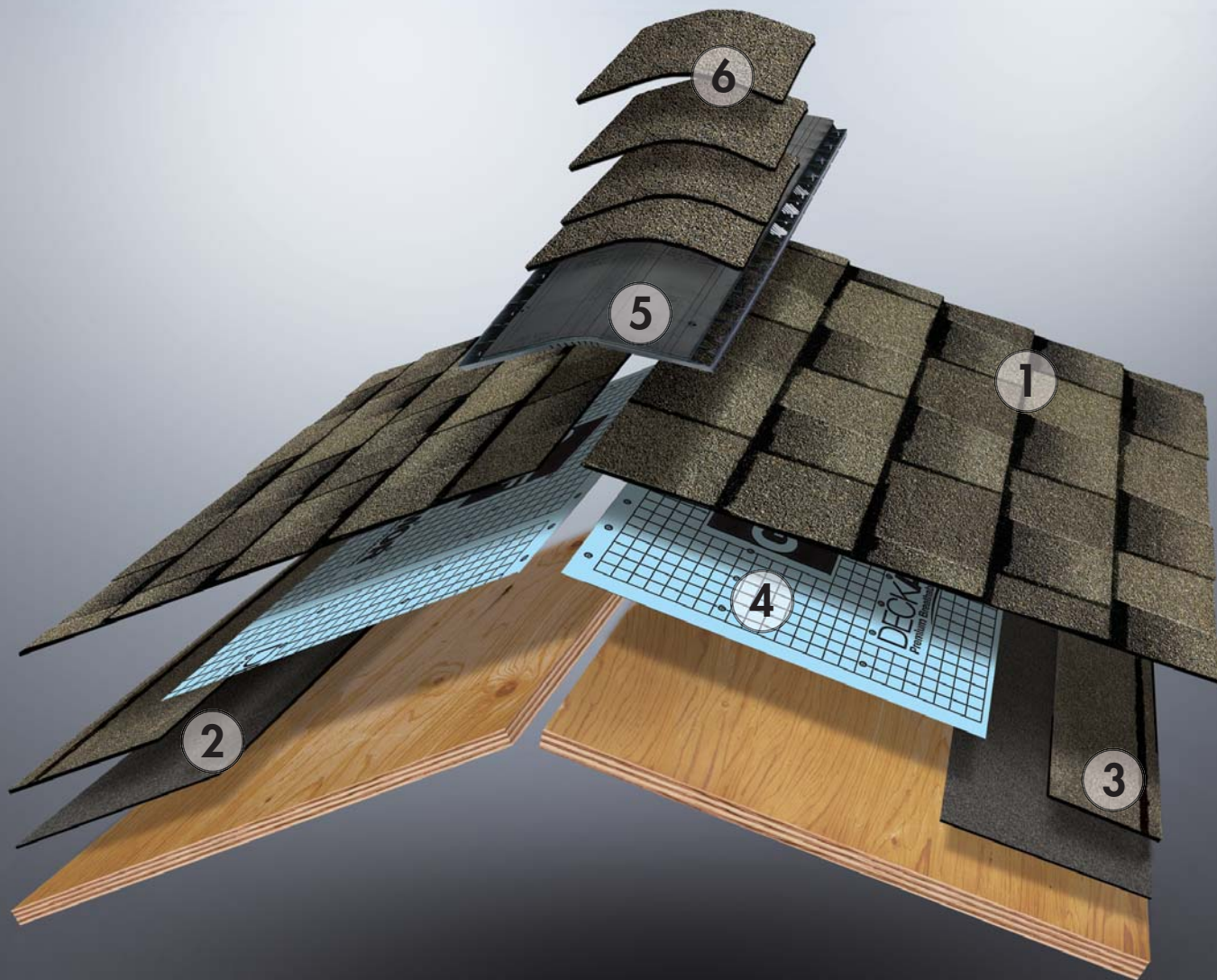

**1 Lifetime<sup>†</sup> Shingles**

GAF offers you many great Lifetime Shingle choices, including **Timberline<sup>®</sup>** Shingles with Advanced Protection<sup>®</sup> Shingle Technology. They're the #1-selling shingles in North America! Advanced Protection<sup>®</sup> Shingle Technology results in excellent protection for your home while reducing the use of precious natural resources. That's better for your home — and better for the environment!

To learn more about why Advanced Protection<sup>®</sup> Shingles are your best choice, visit [gaf.com/APS/](http://gaf.com/APS/).

**2 Leak Barrier**

Provides excellent protection against leaks caused by roof settling and extreme weather. Ideal upgrade at all vulnerable areas (including at the eaves in the North\*).



**3 Starter Strip Shingles**

Saves time, eliminates waste, and helps reduce risk of shingle blow-off...and may help qualify for upgraded wind warranty coverage (see *GAF Shingle & Accessory Ltd. Warranty* for details).



**4 Roof Deck Protection**

Provides a strong layer of protection against wind-driven rain and moisture infiltration.



The GAF Lifetime Roofing System has earned the prestigious Good Housekeeping Seal, which means that Good Housekeeping stands behind the products in this system. (Refer to Good Housekeeping Magazine for its consumer protection policy. Applicable in U.S. only.)

**5 Cobra<sup>®</sup> Attic Ventilation**

Helps remove excess heat and moisture from your attic to promote energy efficiency in your home and help extend the life of your roof.



**6 Ridge Cap Shingles**

Enhances the beauty of your home while helping guard against leaks at the hips and ridges.



\*In the North, most building codes require the use of Leak Barrier at the eaves.

<sup>†</sup> See *GAF Shingle & Accessory Ltd. Warranty* for complete coverage and restrictions. The word "Lifetime" refers to the length of coverage provided by the *GAF Shingle & Accessory Ltd. Warranty* and means as long as the original individual owner(s) of a single-family detached residence (or the second owner(s) in certain circumstances) owns the property where the shingles and accessories are installed. For owners/structures not meeting the above criteria, Lifetime coverage is not applicable. Lifetime Ltd. warranty on accessories requires the use of at least three qualifying GAF accessories and the use of Lifetime Shingles.



# Advanced Protection®

## State-of-the-art technology helped us design our Advanced Protection® Shingles.

Test models similar to those used in America's space program, combined with some of the hardest minerals found on Earth, help GAF Advanced Protection® Shingles perform and protect like nothing else. No one makes a better asphalt shingle for toughness, flexibility, and heroic resistance to wind, weather, and fire. Plus, their advanced design requires fewer natural resources to manufacture and transport.

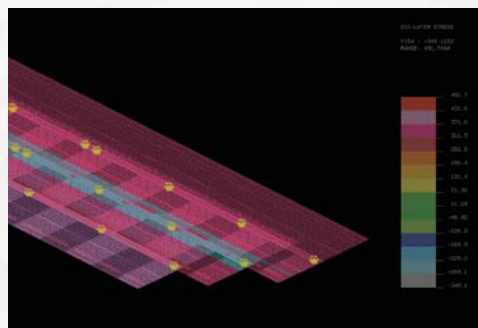

Sophisticated computer models (similar to those used to test the space shuttle) help predict long-term stresses at 10,000 points on GAF Shingles.



To learn more about **Advanced Protection®** Shingles, visit [gaf.com/APS/](http://gaf.com/APS/)



Engineered layer by layer for maximum durability.

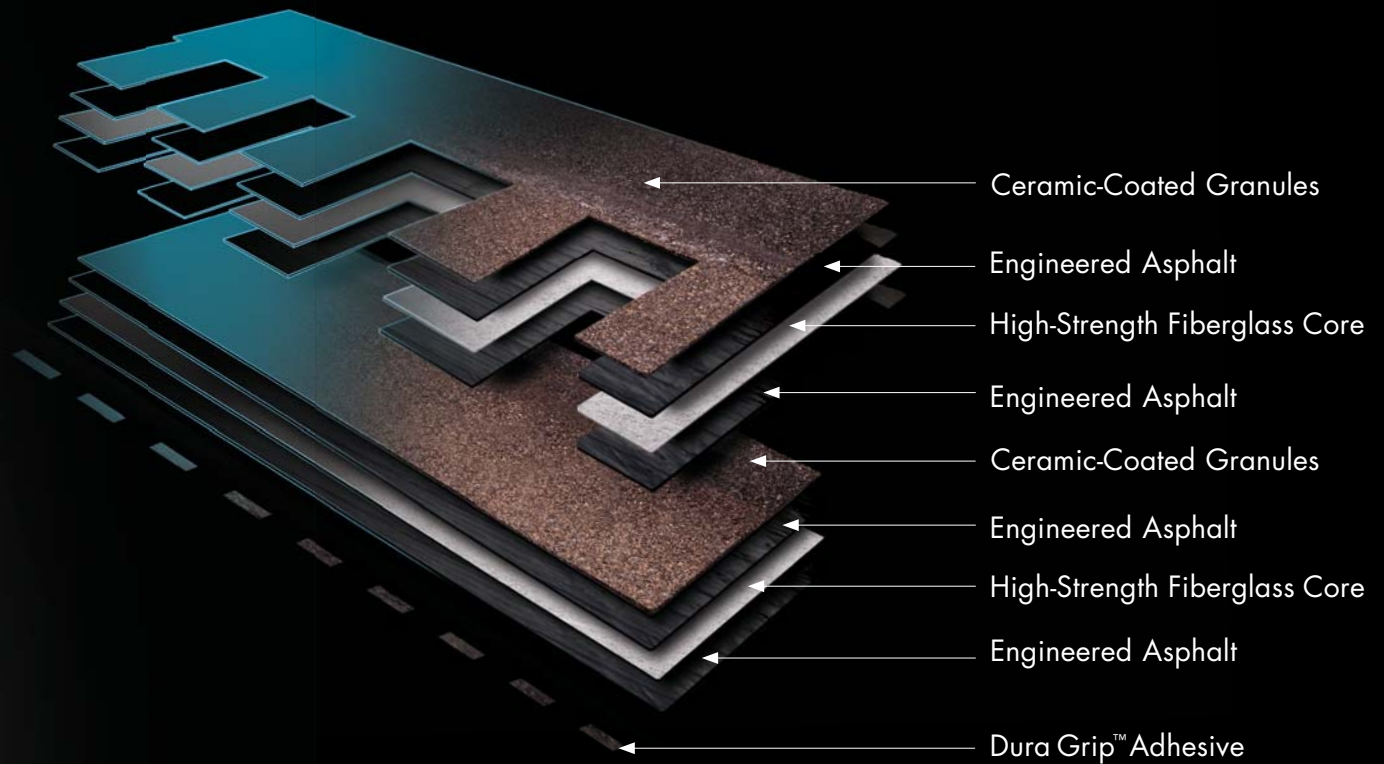

## Advanced Protection® Shingles: the inside story.



**Tough to the core.** The high-strength fiberglass core at the heart of the system uses GAF proprietary low-profile technology for a shingle with extraordinary durability.

**Engineered with you in mind.** Unique asphalt formulations for every plant, plus custom adhesives designed to stand up to the specific climate challenges in your area, including temperature extremes from Arizona to Alaska.

**Protection on top of protection.** Ceramic-coated granules, made from some of the hardest minerals on Earth, protect against UV damage while providing vivid color that will stand the test of time.



# Timberline®

*America's Favorite Roof*

- Timberline Ultra HD®
- Timberline HD®
- Timberline® American Harvest®
- Timberline® Natural Shadow®
- Timberline® Cool Series®



## Timberline® Shingles.



U.S. only



\* StainGuard® protection applies only to shingles with StainGuard®-labeled packaging. See GAF Shingle & Accessory Ltd. Warranty for complete coverage and restrictions.



Protecting what you value most.





# Install Peace Of Mind

Whether you install the ultra-dimensional Timberline Ultra HD® Shingles or the ever-popular Timberline HD® Shingles, you'll be getting all the benefits that only a genuine Timberline® roof can provide!



U.S. only



\*See GAF Shingle & Accessory Ltd. Warranty for complete coverage and restrictions. The word "Lifetime" refers to the length of coverage provided by the GAF Shingle & Accessory Ltd. Warranty and means as long as the original individual owner(s) of a single-family detached residence [or the second owner(s) in certain circumstances] owns the property where the shingles are installed. For owners/structures not meeting the above criteria, Lifetime coverage is not applicable.

\*\*Timberline® High Definition® Shingles have earned the prestigious Good Housekeeping Seal, which means that Good Housekeeping stands behind these products. (Refer to Good Housekeeping Magazine for its consumer protection policy. Applicable in U.S. only.)

<sup>1</sup>StainGuard® protection applies only to shingles with StainGuard®-labeled packaging. See GAF Shingle & Accessory Ltd. Warranty for complete coverage and restrictions.

<sup>2</sup>Based on a 2014 survey of U.S. homeowners commissioned by GAF comparing the appearance of two popular Timberline® High Definition® Shingle colors to the comparable colors of other leading brands.

<sup>3</sup>2013 National Association of REALTORS® survey commissioned by GAF of REALTOR® Appraisers and Non-Appraisers in the U.S.; response based on REALTOR® Appraisers that have had professional experience buying or selling a home with Timberline® Shingles in the three years preceding the survey and felt they could provide an estimated value increase for a home with a Timberline® roof as compared to a home with a basic three-tab shingle roof.

## Install To Protect.

When you install GAF Timberline® High Definition® Shingles with **Advanced Protection®** Shingle Technology, you're getting the very best combination of weight and performance that modern manufacturing technology can deliver. In fact, you won't find a shingle that surpasses Timberline® on:

- ✓ Toughness
- ✓ Wind uplift resistance
- ✓ Flexibility
- ✓ Fire resistance

That's why every Timberline® High Definition® Shingle comes with GAF's transferable Lifetime ltd. warranty\* — for your peace of mind! — plus the backing of the Good Housekeeping Seal.\*\*





## Install To **Invest.**

Your roof can represent up to 40% of your home's "curb appeal." Timberline® High Definition® Shingles not only protect your most valuable asset but also beautify your home for years to come — and add to its resale value.

An independent research firm surveyed U.S. homeowners about the brand of architectural shingles they preferred based on appearance. The result: **more homeowners preferred the look of Timberline® High Definition® Shingles** to the other leading brands.<sup>2</sup>

In fact, according to a survey conducted by the National Association of REALTORS®, you can increase the value of your home by an average of 5% with a new Timberline® roof!<sup>3</sup>

So why settle for anything less than a genuine Timberline® roof?

## Install To **Impress.**

Timberline® High Definition® Shingles are unlike any others, thanks to our proprietary shadow bands. Each shadow band is applied using a sophisticated, computer-controlled "feathering" technique. When combined with our randomly blended top layer, it results in a shingle with exceptional depth and dimension — **and a striking look unmatched by any other brand.**

But don't just take our word for it. See for yourself. When you compare Timberline® High Definition® Shingles to typical architectural shingles, it's easy to see why they'll look sharper and more beautiful on your roof — while enhancing the resale value of your home.

Whatever you're looking for, there's a Timberline® Shingle to fit your taste and your budget.

<sup>2,3</sup>See footnotes on previous page



# TIMBERLINE ULTRAHD

LIFETIME HIGH DEFINITION SHINGLES

Color Shown:  
Charcoal

TIMBERLINE® LIFETIME SHINGLES



U.S. only

\*StainGuard® protection applies only to shingles with StainGuard-labeled packaging. See GAF Shingle & Accessory Ltd. Warranty for complete coverage and restrictions.

Note: It is difficult to reproduce the color clarity and actual color blends of these products. Before selecting your color, please ask to see several full-size shingles.



TIMBERLINE® LIFETIME SHINGLES — NORTH AMERICA'S #1 — SELLING ROOF

## Your Best Investment For An **Ultra-Dimensional** Wood-Shake Look

- **Best Investment...** Just pennies-a-day more than standard architectural shingles.<sup>1</sup>
- **Ultra-Dimensional Look...** Up to 53% thicker than standard architectural shingles,<sup>1</sup> Timberline Ultra HD® Shingles feature GAF's proprietary color blends and enhanced shadow effect for an ultra-dimensional wood-shake look on your roof.
- **Highest Roofing Fire Rating...** UL Class A, Listed to ANSI/UL 790.
- **High Performance...** Designed with Advanced Protection® Shingle Technology, which reduces the use of natural resources while providing excellent protection for your home (visit [gaf.com/APS/](http://gaf.com/APS/) to learn more).
- **Stays In Place...** Dura Grip™ Adhesive seals each shingle tightly and reduces the risk of shingle blow-off. Shingles are warranted to withstand winds up to 130 mph (209 km/h).<sup>2</sup>
- **Peace Of Mind...** Lifetime Ltd. transferable warranty with Smart Choice® Protection (non-prorated material and installation labor coverage) for the first ten years.<sup>3</sup>
- **Perfect Finishing Touch...** Use Timbertex® Premium Ridge Cap Shingles or Ridglass® Premium Ridge Cap Shingles (visit [www.gaf.com/ridgecapavailability](http://www.gaf.com/ridgecapavailability) for availability in your area).

<sup>1</sup> Note: Comparison refers to Timberline HD® Shingles. Thickness varies by plant; see actual shingles for comparison.  
<sup>2</sup> This wind speed coverage requires special installation; see GAF Shingle & Accessory Ltd. Warranty for details.  
<sup>3</sup> See GAF Shingle & Accessory Ltd. Warranty for complete coverage and restrictions. The word "Lifetime" refers to the length of coverage provided by the GAF Shingle & Accessory Ltd. Warranty and means as long as the original individual owner(s) of a single-family detached residence (or the second owner(s) in certain circumstances) owns the property where the shingles are installed. For owners/structures not meeting the above criteria, Lifetime coverage is not applicable.  
<sup>4</sup> Rated by the Cool Roof Rating Council (CRRC), can be used to comply with Title 24 roofing product requirements, and meets the Los Angeles Green Building Code.  
<sup>5</sup> Limited availability.  
<sup>6</sup> Timberline HD® White is ENERGY STAR® certified (U.S. only).

Most Popular High Definition® Shingle Colors    Regional High Definition® Shingle Colors

See chart on page 14 for regional color availability.

### Where They Fit Within The Lifetime Roofing System

#### 1. Lifetime Shingles

2. Leak Barrier
3. Starter Strip Shingles
4. Roof Deck Protection
5. Cobra® Attic Ventilation
6. Ridge Cap Shingles

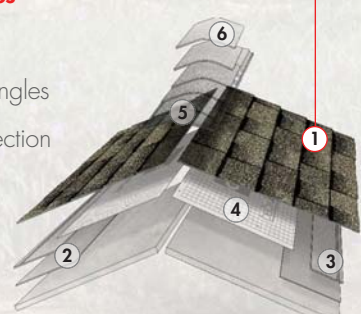



# TIMBERLINE HD

LIFETIME HIGH DEFINITION SHINGLES

Color Shown:  
Pewter Gray

TIMBERLINE® LIFETIME SHINGLES



U.S. only



\*StainGuard® protection applies only to shingles with StainGuard-labeled packaging. See GAF Shingle & Accessory Ltd. Warranty for complete coverage and restrictions.

Note: It is difficult to reproduce the color clarity and actual color blends of these products. Before selecting your color, please ask to see several full-size shingles.



**Barkwood**

**Hickory**

**Shakewood**

**Weathered Wood**

**Charcoal**

**Hunter Green**

**Slate**

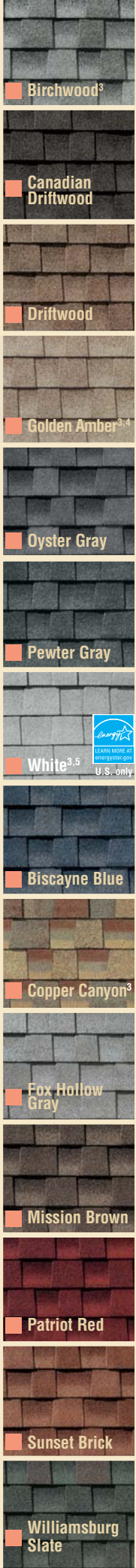

**Birchwood<sup>3</sup>**

**Canadian Driftwood**

**Driftwood**

**Golden Amber<sup>3,4</sup>**

**Oyster Gray**

**Pewter Gray**

**White<sup>3,5</sup>**

**Biscayne Blue**

**Copper Canyon<sup>3</sup>**

**Fox Hollow Gray**

**Mission Brown**

**Patriot Red**

**Sunset Brick**

**Williamsburg Slate**

TIMBERLINE® LIFETIME SHINGLES — NORTH AMERICA'S #1 — SELLING ROOF

# Value And Performance In A Genuine Wood-Shake Look

- **Great Value...** Architecturally stylish but practically priced — with a Lifetime Ltd. warranty.<sup>1</sup>
- **Dimensional Look...** Features GAF's proprietary color blends and enhanced shadow effect for a genuine wood-shake look.
- **Highest Roofing Fire Rating...** UL Class A, Listed to ANSI/UL 790.
- **High Performance...** Designed with Advanced Protection® Shingle Technology, which reduces the use of natural resources while providing excellent protection for your home (visit [gaf.com/APS](http://gaf.com/APS) to learn more).
- **Stays In Place...** Dura Grip™ Adhesive seals each shingle tightly and reduces the risk of shingle blow-off. Shingles are warranted to withstand winds up to 130 mph (209 km/h).<sup>2</sup>
- **Peace Of Mind...** Lifetime Ltd. transferable warranty with Smart Choice® Protection (non-prorated material and installation labor coverage) for the first ten years.<sup>1</sup>
- **Perfect Finishing Touch...** Use Timbertex® Premium Ridge Cap Shingles or Ridglass® Premium Ridge Cap Shingles (visit [www.gaf.com/ridgecapavailability](http://www.gaf.com/ridgecapavailability) for availability in your area).

<sup>1</sup> See GAF Shingle & Accessory Ltd. Warranty for complete coverage and restrictions. The word "Lifetime" refers to the length of coverage provided by the GAF Shingle & Accessory Ltd. Warranty and means as long as the original individual owner(s) of a single-family detached residence [or the second owner(s) in certain circumstances] owns the property where the shingles are installed. For owners/structures not meeting the above criteria, Lifetime coverage is not applicable.

<sup>2</sup> This wind speed coverage requires special installation; see GAF Shingle & Accessory Ltd. Warranty for details.

<sup>3</sup> Rated by the Cool Roof Rating Council (CRRRC), can be used to comply with Title 24 roofing product requirements, and meets the Los Angeles Green Building Code.

<sup>4</sup> Limited availability.

<sup>5</sup> Timberline HD® White is ENERGY STAR® certified (U.S. only).

Most Popular High Definition® Shingle Colors    Regional High Definition® Shingle Colors

See chart on page 14 for regional color availability.

## Where They Fit Within The Lifetime Roofing System

1. Lifetime Shingles
2. Leak Barrier
3. Starter Strip Shingles
4. Roof Deck Protection
5. Cobra® Attic Ventilation
6. Ridge Cap Shingles

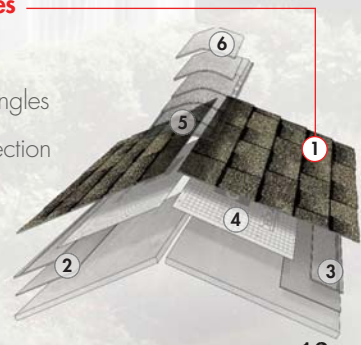



**TIMBERLINE ULTRA HD**  
LIFETIME HIGH DEFINITION SHINGLES

**TIMBERLINE HD**  
LIFETIME HIGH DEFINITION SHINGLES

# Color Availability

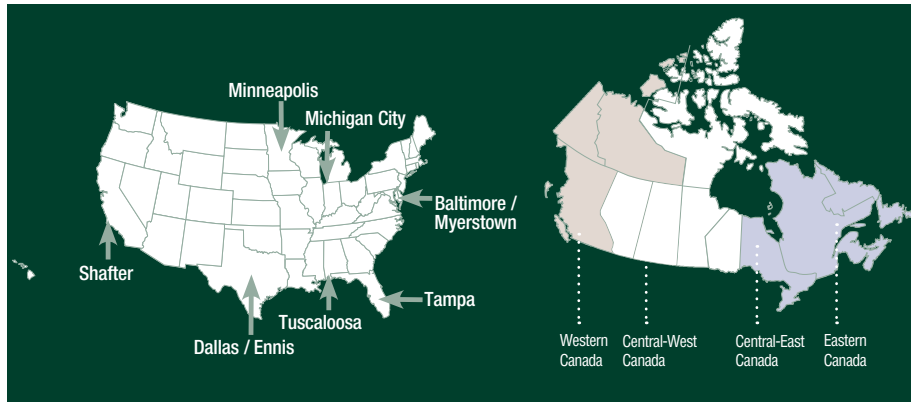

Product Key:	
● - Timberline HD®	▲ - Timberline Ultra HD®

	Ask your contractor which of these GAF plants supplies the shingles in your area...										
	Baltimore, MD/Myerstown, PA	Dallas/Ennis, TX	Michigan City, IN	Minneapolis, MN	Shafter, CA	Tampa, FL	Tuscaloosa, AL	Western Canada	Central-West Canada	Central-East Canada	Eastern Canada
<b>Most Popular Colors:</b>											
Barkwood	● ▲	● ▲	● ▲	● ▲	● ▲	● ▲	● ▲	● ▲	● ▲	● ▲	● ▲
Charcoal	● ▲	● ▲	● ▲	● ▲	● ▲	● ▲	● ▲	● ▲	● ▲	● ▲	● ▲
Hickory	● ▲	●	● ▲	● ▲	● ▲	●	●	● ▲	● ▲	● ▲	● ▲
Hunter Green	● ▲	●	●	● ▲	●	●	●			●	● ▲
Shakewood	● ▲	●	● ▲	● ▲	● ▲	● ▲	● ▲	● ▲	● ▲	● ▲	● ▲
Slate	● ▲	●	●	●	● ▲	● ▲	● ▲	● ▲		●	▲
Weathered Wood	● ▲	● ▲	● ▲	● ▲	● ▲	● ▲	● ▲	● ▲	● ▲	● ▲	● ▲
<b>Regional Colors:</b>											
Birchwood <sup>1</sup>			●	●	● ▲	●	●	● ▲	●	●	
Biscayne Blue	● ▲										▲
Canadian Driftwood								●	●	●	●
Copper Canyon <sup>1</sup>					●						
Driftwood						●	●				
Fox Hollow Gray	● ▲		●								▲
Golden Amber <sup>1,2</sup>					●						
Mission Brown	●	●	●	●	●			●	●	●	●
Oyster Gray	●										
Patriot Red	● ▲		▲	▲					▲	▲	▲
Pewter Gray	● ▲	●	● ▲	● ▲	● <sup>2</sup>		● ▲	●	● ▲	● ▲	● ▲
Sunset Brick						●					
White <sup>1,3</sup>						●	●				
Williamsburg Slate	●		●								

<sup>1</sup>Rated by the Cool Roof Rating Council (CRRCC), can be used to comply with Title 24 roofing product requirements, and meets the Los Angeles Green Building Code.

<sup>2</sup>Limited availability.

<sup>3</sup>Timberline HD® White is ENERGY STAR® certified (U.S. only).

## Most Popular

### High Definition® Shingle Colors

(Available nationwide)



## Regional

### High Definition® Shingle Colors

(See chart at left for availability)



\*StainGuard® protection applies only to shingles with StainGuard-labeled packaging. See *GAF Shingle & Accessory Ltd. Warranty* for complete coverage and restrictions.

*Note: It is difficult to reproduce the color clarity and actual color blends of these products. Before selecting your color, please ask to see several full-size shingles.*



1, 2, 3 See footnotes on previous page





# TIMBERLINE® American Harvest®

LIFETIME SHINGLES

(Only available in the U.S.)

Designed to complement your home's exterior color scheme, the American Harvest® Collection will give you that modern architectural style you want, at a price you can afford!

The Timberline® American Harvest® line has been enhanced for maximum appeal, adding greater dimensionality and beauty with higher contrast and on-trend colors.



TIMBERLINE® LIFETIME SHINGLES



U.S. only



\*See GAF Shingle & Accessory Ltd. Warranty for complete coverage and restrictions.

Note: It is difficult to reproduce the color clarity and actual color blends of these products. Before selecting your color, please ask to see several full-size shingles.



Color Shown:  
Golden Harvest



Saddlewood Ranch



Cedar Falls



Nantucket Morning



Appalachian Sky



Golden Harvest



Midnight Blush\*



Amber Wheat\*\*

TIMBERLINE® LIFETIME  
SHINGLES — NORTH AMERICA'S  
#1 — SELLING ROOF

## Surprising Colors That Reflect The Beauty Of America's Heartland

- **Custom-Designed Color Palette...** Professionally designed color palette featuring subtle blends with contrasting colors that will add sophistication and charm to any home.
- **Extra-Dimensional...** Optimized construction and advanced color application techniques result in an extra-dimensional look.
- **Great Value...** Architecturally stylish, but practically priced — with a Lifetime Ltd. warranty.<sup>1</sup>
- **Highest Roofing Fire Rating...** UL Class A, Listed to ANSI/UL 790.
- **High Performance...** Designed with Advanced Protection® Shingle Technology, which reduces the use of natural resources while providing excellent protection for your home (visit [gaf.com/APS/](http://gaf.com/APS/) to learn more).
- **Stays In Place...** Dura Grip™ Adhesive seals each shingle tightly and reduces the risk of shingle blow-off. Shingles warranted to withstand winds up to 130 mph!<sup>2</sup>
- **Peace Of Mind...** Lifetime Ltd. transferable warranty with Smart Choice® Protection (non-prorated material and installation labor coverage) for the first ten years!<sup>1</sup>
- **Perfect Finishing Touch...** Use Timbertex® Premium Ridge Cap Shingles with StainGuard® protection or Ridglass® Premium Ridge Cap Shingles.<sup>3</sup>

<sup>1</sup> See GAF Shingle & Accessory Ltd. Warranty for complete coverage and restrictions. The word "Lifetime" refers to the length of coverage provided by the GAF Shingle & Accessory Ltd. Warranty and means as long as the original individual owner(s) of a single-family detached residence (or the second owner(s) in certain circumstances) owns the property where the shingles are installed. For owners/structures not meeting the above criteria, Lifetime coverage is not applicable.

<sup>2</sup> This wind speed coverage requires special installation; see GAF Shingle & Accessory Ltd. Warranty for details.

<sup>3</sup> These products are not available in all areas. See [www.gaf.com/ridgecapavailability](http://www.gaf.com/ridgecapavailability) for details.

\*Available only in the Northeast and Central Areas of the U.S.

\*\*Available only in the Southeastern, Southwestern, and Western Areas of the U.S.

### Where They Fit Within The Lifetime Roofing System

#### 1. Lifetime Shingles

2. Leak Barrier
3. Starter Strip Shingles
4. Roof Deck Protection
5. Cobra® Attic Ventilation
6. Ridge Cap Shingles

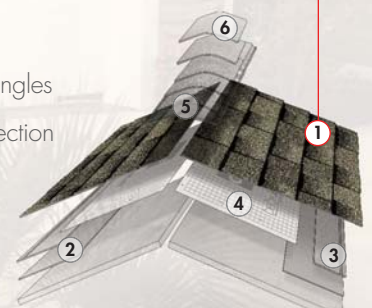



# TIMBERLINE® *Natural Shadow* LIFETIME SHINGLES

(Only available in the U.S.)

Color Shown:  
**Barkwood**

TIMBERLINE® LIFETIME SHINGLES



U.S. only



\*StainGuard® protection applies only to shingles with StainGuard-labeled packaging. See GAF Shingle & Accessory Ltd. Warranty for complete coverage and restrictions.

Note: It is difficult to reproduce the color clarity and actual color blends of these products. Before selecting your color, please ask to see several full-size shingles.



**Barkwood\***

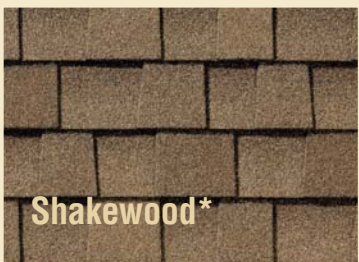

**Shakewood\***



**Slate\***



**Weathered Wood\***

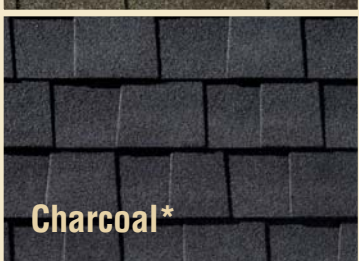

**Charcoal\***



**Hickory\***



**Pewter Gray\***

ENERGY STAR® CERTIFIED! (White Only)



**Arctic White\***



TIMBERLINE® LIFETIME SHINGLES — NORTH AMERICA'S #1 — SELLING ROOF

# Value & Performance In A Natural Wood-Shake Look

- **Attractive Appearance...** Features a classic shadow effect. Lends any home a subtle, even-toned look with the warmth of wood.
- **Great Value...** Architecturally stylish but practically priced.
- **High Performance...** Designed with Advanced Protection® Shingle Technology, which reduces the use of natural resources while providing excellent protection for your home (visit [gaf.com/APS/](http://gaf.com/APS/) to learn more).
- **Highest Roofing Fire Rating...** UL Class A, Listed to ANSI/UL 790.
- **Stays In Place...** Dura Grip™ Adhesive seals each shingle tightly and reduces the risk of shingle blow-off. Shingles are warranted to withstand winds up to 130 mph.<sup>1</sup>
- **Peace Of Mind...** Lifetime Ltd. transferable warranty with Smart Choice® Protection (non-prorated material and installation labor coverage) for the first ten years.<sup>2</sup>
- **Perfect Finishing Touch...** Use Timbertex® Premium Ridge Cap Shingles or Ridglass® Premium Ridge Cap Shingles.<sup>3</sup>

<sup>1</sup> This wind speed coverage requires special installation; see *GAF Shingle & Accessory Ltd. Warranty* for details.

<sup>2</sup> See *GAF Shingle & Accessory Ltd. Warranty* for complete coverage and restrictions. The word "Lifetime" refers to the length of coverage provided by the *GAF Shingle & Accessory Ltd. Warranty* and means as long as the original individual owner(s) of a single-family detached residence [or the second owner(s) in certain circumstances] owns the property where the shingles are installed. For owners/structures not meeting the above criteria, Lifetime coverage is not applicable.

<sup>3</sup> These products are not available in all areas. See [www.gaf.com/ridgecapavailability](http://www.gaf.com/ridgecapavailability) for details.

- \*Notes on Color Availability:
- Arctic White only available in the Shafter area.
  - Pewter Gray only available in the Baltimore/Myerstown and Michigan City areas.
  - Timberline® Natural Shadow® Shingles are not available in the Tampa area.

## Where They Fit Within The Lifetime Roofing System

### 1. Lifetime Shingles

2. Leak Barrier
3. Starter Strip Shingles
4. Roof Deck Protection
5. Cobra® Attic Ventilation
6. Ridge Cap Shingles

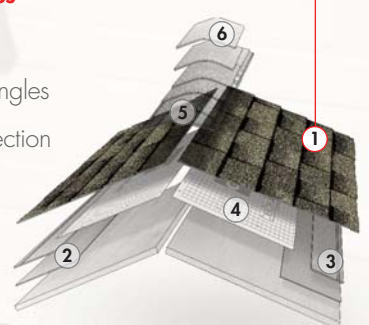



The revolutionary Timberline® Cool Series® Shingles reflect sunlight to help reduce unwanted attic heat build-up and may help save on air-conditioning costs<sup>1</sup>. They are rated by the Cool Roof Rating Council (CRRC) and are ENERGY STAR® certified (U.S. only).<sup>2,3</sup>



Color Shown:  
**Cool Barkwood**

**Cool Barkwood**

**Cool Antique Slate**

**Cool Weathered Wood**

TIMBERLINE® LIFETIME SHINGLES — NORTH AMERICA'S #1 — SELLING ROOF

## Revolutionary Cool Roofing

- **Helps Reduce Cooling Costs...** According to the Cool Roof Rating Council, cool roofs may save you an average of 7–15% on your total cooling costs.<sup>1</sup>
- **Rebates...** Some utility companies may provide incentives for using cool shingles.

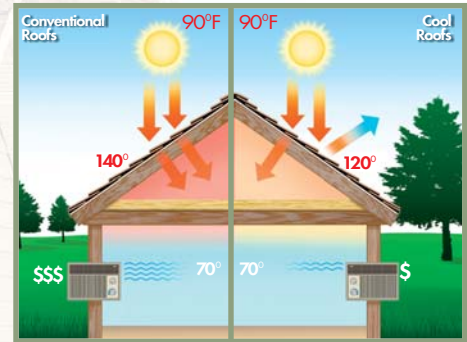

Thanks to the reflective nature of Timberline® Cool Series® Shingles, part of the heat radiating from the sun gets reflected, helping to reduce the heat in the attic and heat going into the house. It may translate into savings on air-conditioning bills.<sup>1</sup>

### TIMBERLINE® COOL SERIES® REFLECTANCE & EMITTANCE DATA

Color	Initial Solar Reflectance	Thermal Emittance	Solar Reflectance Index (SRI)
Cool Antique Slate	0.27	0.92	29
Cool Barkwood	0.27	0.92	29
Cool Weathered Wood	0.26	0.92	29

<sup>1</sup> Potential for savings depends on various factors including, but not limited to, climate zone, utility rates, location, and HVAC equipment efficiency.

<sup>2</sup> All three Cool Colors meet the prescriptive requirements of 2013 Title 24, Part 6, of the California Code of Regulations, and meet the Los Angeles Green Building Code.

<sup>3</sup> When installed properly, this product will help reduce energy costs. Actual savings will vary based on geographic location and individual building characteristics. For more information, contact GAF Technical Services at 1-800-ROOF-411, visit gaf.com, or call 1-888-STAR-YES.

### Where They Fit Within The Lifetime Roofing System

#### 1. Lifetime Shingles

2. Leak Barrier
3. Starter Strip Shingles
4. Roof Deck Protection
5. Cobra® Attic Ventilation
6. Ridge Cap Shingles

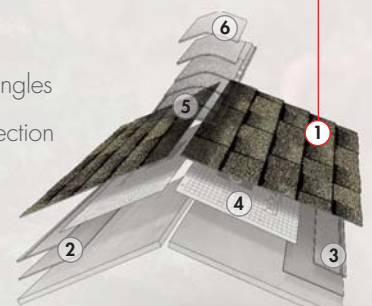



# Lifetime<sup>1</sup> Designer Shingles

## Ultra-Premium Collection

- Glenwood<sup>®</sup>
- Camelot<sup>®</sup>
- Grand Canyon<sup>®</sup>

## Value Collection

- Sienna<sup>®</sup>
- Woodland<sup>®</sup>
- Monaco<sup>®</sup>
- Camelot<sup>®</sup> II
- Grand Sequoia<sup>®</sup>
- Slateline<sup>®</sup>

### PREMIUM COLOR BLENDS

Drawing on GAF's deep expertise in shingle color design, our experts have developed Premium Color Blends — unique shingle color blends that combine our latest granule colors with GAF's advanced blending technology, resulting in exceptionally vibrant, premium color options for your home. These select blends are available on certain shingles across our Lifetime Designer Shingle collection.

As with all our Lifetime Designer Shingle color blends, GAF Premium Color Blends complement a wide variety of home styles. So no matter which of our shingle color blends you choose, you'll not only be certain to increase your home's curb appeal — you'll also be sure to love its look. Just look for the Premium Color Blend logo!

<sup>1</sup> See footnote on next page





- **Affordable Luxury...** GAF Lifetime Designer Shingles are only a fraction of the cost of traditional slate or wood shakes
- **Sophisticated Designs...** Artisan-crafted shapes combined with dimensional designs result in a sophisticated beauty unmatched by typical shingles
- **Custom Color Palettes...** Specially formulated color palettes are designed to accentuate each shingle's natural appeal
- **High Performance...** Designed with Advanced Protection® Shingle Technology, which reduces the use of natural resources while providing excellent protection for your home (visit [gaf.com/APS/](http://gaf.com/APS/) to learn more)
- **StainGuard® Protection...** Helps ensure the beauty of your roof against unsightly blue-green algae<sup>2</sup>
- **Highest Roofing Fire Rating...** UL Class A, Listed to ANSI/UL 790
- **Stays In Place...** Dura Grip™ Adhesive seals each shingle tightly and reduces the risk of shingle blow-off. Shingles warranted to withstand winds up to 130 mph (209 km/h)!<sup>3</sup>
- **The Ultimate Peace Of Mind...** Lifetime Ltd. transferable warranty with Smart Choice® Protection (non-prorated material and installation labor coverage) for the first ten years<sup>1</sup>
- **Perfect Finishing Touch...** Use Timbertex® Premium Ridge Cap Shingles or Ridglass® Premium Ridge Cap Shingles.<sup>4</sup>



U.S. only



<sup>1</sup> See GAF Shingle & Accessory Ltd. Warranty for complete coverage and restrictions. The word "Lifetime" refers to the length of coverage provided by the GAF Shingle & Accessory Ltd. Warranty and means as long as the original individual owner(s) of a single-family detached residence [or the second owner(s) in certain circumstances] owns the property where the shingles are installed. For owners/structures not meeting the above criteria, Lifetime coverage is not applicable.

<sup>2</sup> StainGuard® protection applies only to shingles with StainGuard®-labeled packaging. See GAF Shingle & Accessory Ltd. Warranty for complete coverage and restrictions.

<sup>3</sup> This wind speed coverage requires special installation. See GAF Shingle & Accessory Ltd. Warranty for details.

<sup>4</sup> These products are not available in all areas. See [www.gaf.com/ridgecapavailability](http://www.gaf.com/ridgecapavailability) for details.

## Where They Fit Within The Lifetime Roofing System

### 1. Lifetime Shingles

2. Leak Barrier
3. Starter Strip Shingles
4. Roof Deck Protection
5. Cobra® Attic Ventilation
6. Ridge Cap Shingles

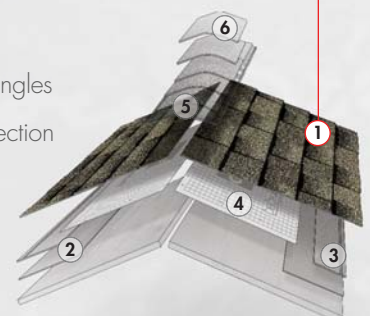





# Glenwood<sup>®</sup>

LIFETIME *Designer* SHINGLES

The Most Authentic Wood Shake-Look Shingles You Can Buy

LIFETIME DESIGNER SHINGLES — ULTRA-PREMIUM COLLECTION



U.S. only

\*See GAF Shingle & Accessory Ltd. Warranty for complete coverage and restrictions.

Note: It is difficult to reproduce the color clarity and actual color blends of these products. Before selecting your color, please ask to see several full-size shingles.

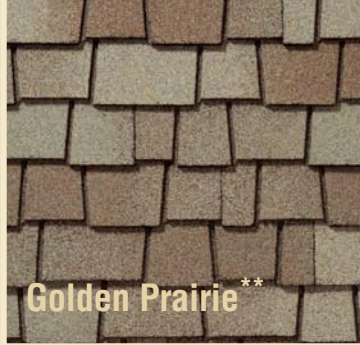

**Golden Prairie\*\***

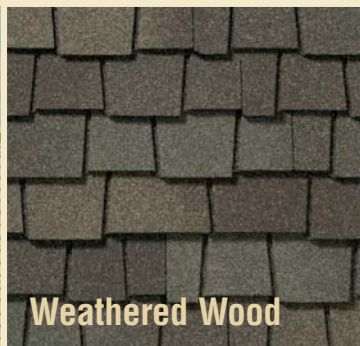

**Weathered Wood**

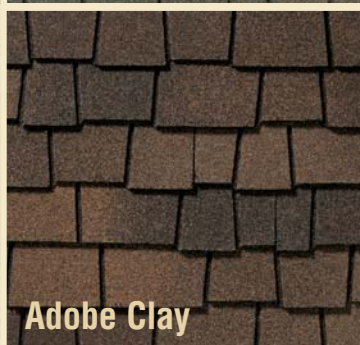

**Adobe Clay**

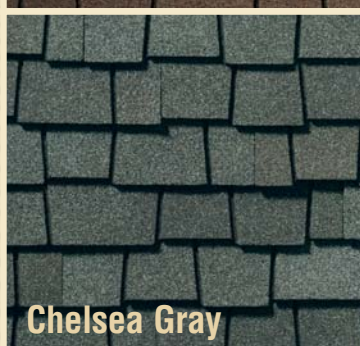

**Chelsea Gray**



**Autumn Harvest**

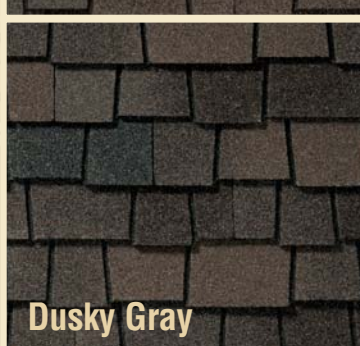

**Dusky Gray**

Color Shown:  
**Golden Prairie\*\***

\*\*Rated by the Cool Roof Rating Council (CRRC), can be used to comply with Title 24 roofing product requirements, and meets the Los Angeles Green Building Code.



**CAMELOT**<sup>®</sup>  
LIFETIME *Designer* SHINGLES

Timeless Beauty...  
Uncompromising Performance

LIFETIME DESIGNER SHINGLES — ULTRA-PREMIUM COLLECTION

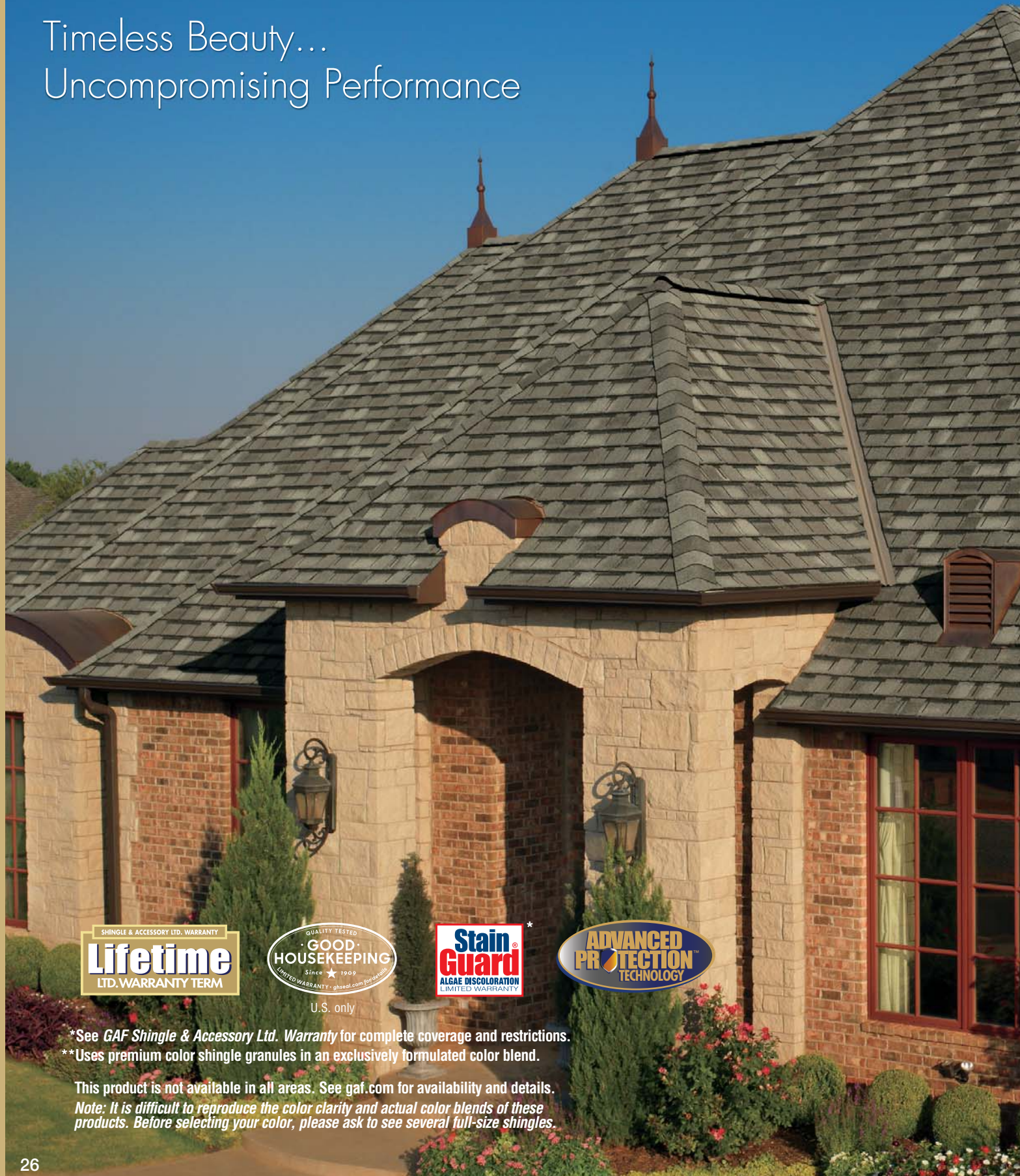

U.S. only

\*See *GAF Shingle & Accessory Ltd. Warranty* for complete coverage and restrictions.  
\*\*Uses premium color shingle granules in an exclusively formulated color blend.

This product is not available in all areas. See [gaf.com](http://gaf.com) for availability and details.  
*Note: It is difficult to reproduce the color clarity and actual color blends of these products. Before selecting your color, please ask to see several full-size shingles.*



Color Shown:  
**Aged Oak**

**Antique Slate**

PREMIUM COLOR BLEND \*\*

**Majestic Navy**

**Aged Oak**

**Welsh Gray**

**San Gabriel**

**Sheffield Black**

PREMIUM COLOR BLEND \*\*

**Royal Slate**

**Williamsburg Slate**

\*\* See footnote on previous page



# Grand Canyon®

LIFETIME *Designer* SHINGLES

The Ultimate Choice For A Rugged Wood-Shake Look

LIFETIME DESIGNER SHINGLES — ULTRA-PREMIUM COLLECTION



U.S. only

\*See GAF Shingle & Accessory Ltd. Warranty for complete coverage and restrictions.

This product is not available in all areas. See [gaf.com](http://gaf.com) for availability and details.  
 Note: It is difficult to reproduce the color clarity and actual color blends of these products. Before selecting your color, please ask to see several full-size shingles.



**Storm Cloud Gray**



**Mission Brown**



**Sedona Sunset**

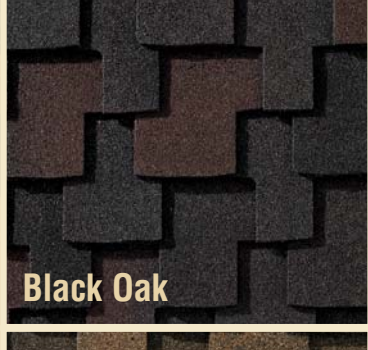

**Black Oak**

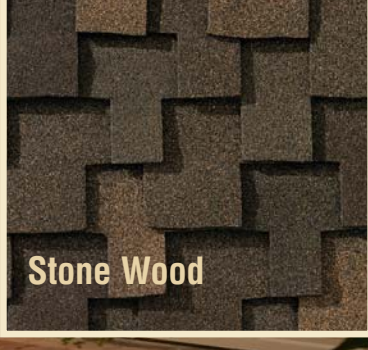

**Stone Wood**

Color Shown:  
**Storm Cloud Gray**



# Sienna<sup>®</sup>

LIFETIME *Designer* SHINGLES

Classic Old World Elegance...  
At An Incredibly Affordable Price



\*See GAF Shingle & Accessory Ltd. Warranty for complete coverage and restrictions.



# Woodland<sup>®</sup>

LIFETIME *Designer* SHINGLES

The Stylish Look Of Hand-Cut  
European Shingles...At An  
Incredibly Affordable Price



\*See GAF Shingle & Accessory Ltd. Warranty for complete coverage and restrictions.

\*\*Uses premium color shingle granules in an exclusively formulated color blend.

Note: It is difficult to reproduce the color clarity and actual color blends of these products. Before selecting your color, please ask to see several full-size shingles.

LIFETIME DESIGNER SHINGLES — VALUE COLLECTION



Color Shown:  
**Aged Oak**



**Aged Oak**



**Harbor Mist**



**Chateau Gray**



**Heirloom Brown**

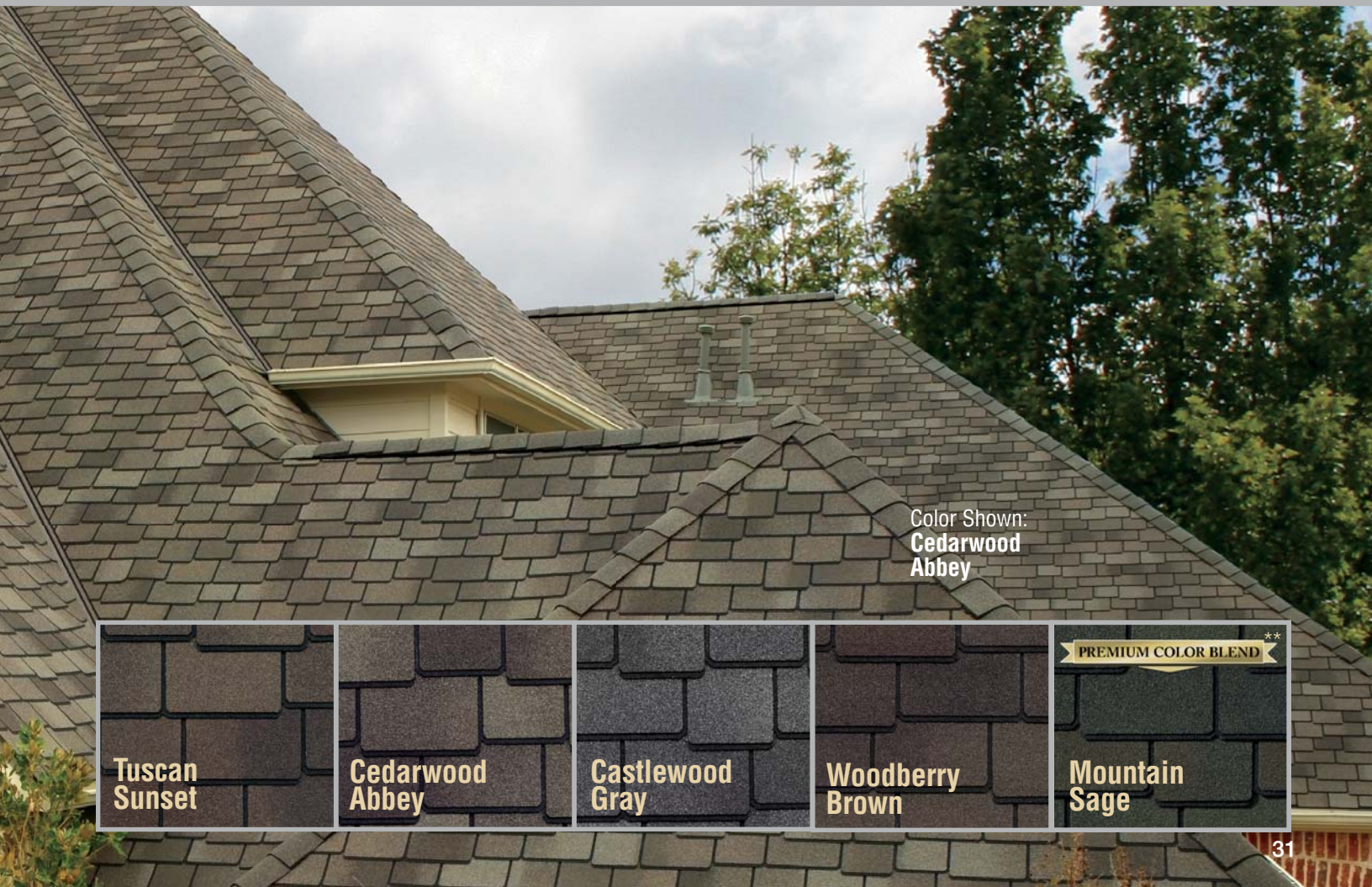

Color Shown:  
**Cedarwood  
Abbey**

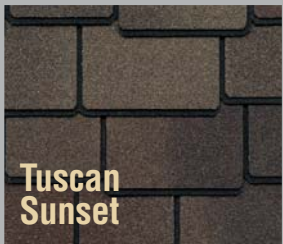

**Tuscan  
Sunset**



**Cedarwood  
Abbey**



**Castlewood  
Gray**

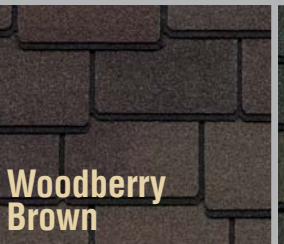

**Woodberry  
Brown**

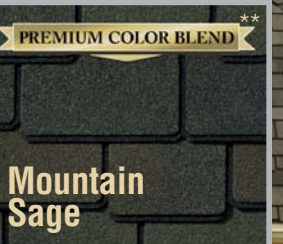

**Mountain  
Sage**

**PREMIUM COLOR BLEND** \*\*



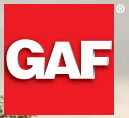

# MONACO<sup>®</sup>

LIFETIME *Designer* SHINGLES

The Look Of Genuine European Tile...  
At An Incredibly Affordable Price



U.S. only



\*See GAF Shingle & Accessory Ltd. Warranty for complete coverage and restrictions.



# CAMELOT<sup>®</sup> II

LIFETIME *Designer* SHINGLES

The Beauty Of GAF's Original  
Camelot<sup>®</sup> Shingle...At An  
Incredibly Affordable Price



U.S. only



\*See GAF Shingle & Accessory Ltd. Warranty for complete coverage and restrictions.

\*\*Uses premium color shingle granules in an exclusively formulated color blend.

Note: It is difficult to reproduce the color clarity and actual color blends of these products. Before selecting your color, please ask to see several full-size shingles.

LIFETIME DESIGNER SHINGLES — VALUE COLLECTION



Color Shown:  
**Monticello  
Brown**



**Venetian  
Coral**

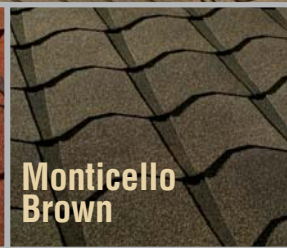

**Monticello  
Brown**



**Valencia  
Sunset**

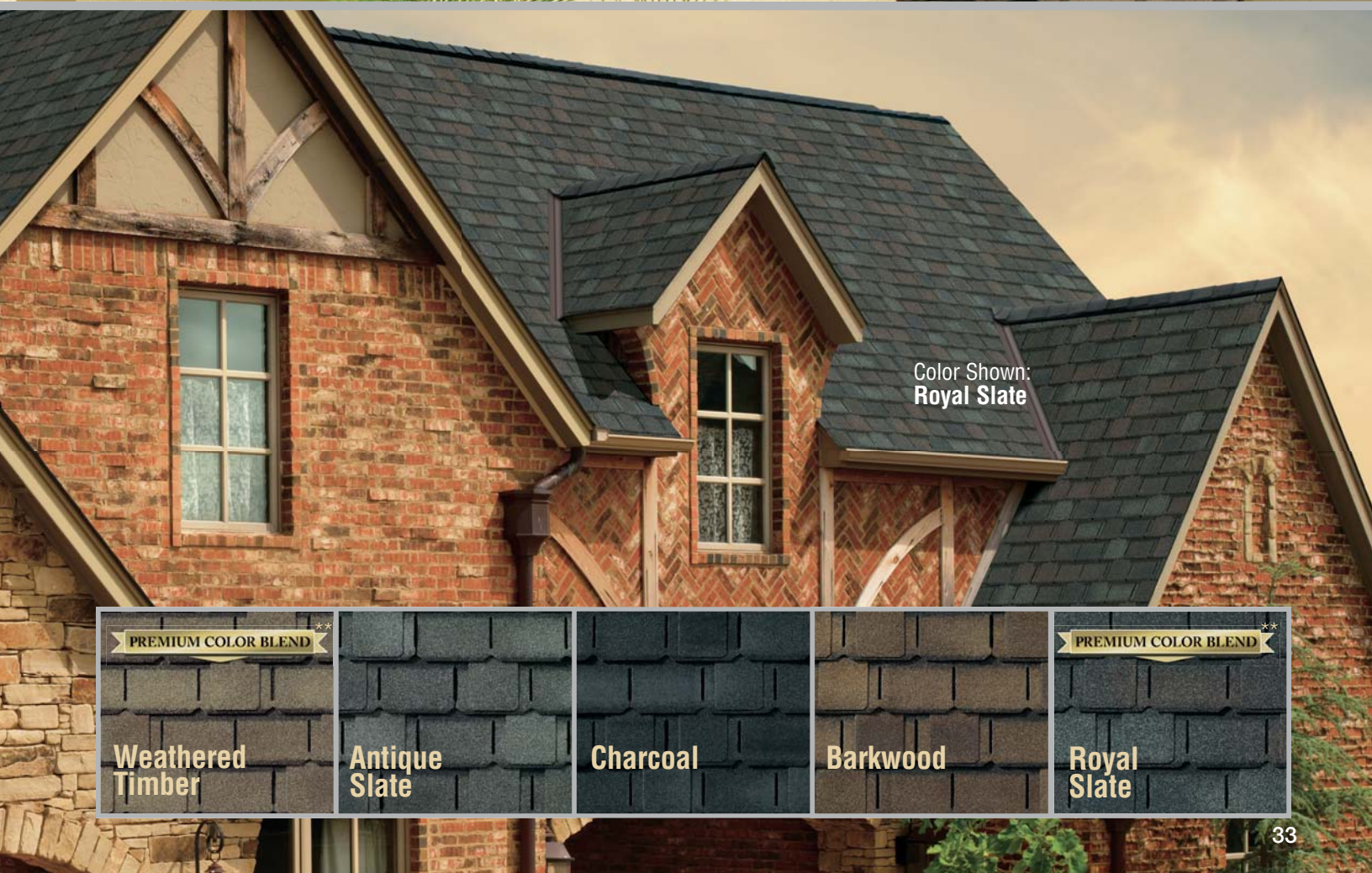

Color Shown:  
**Royal  
Slate**



**PREMIUM COLOR BLEND** \*\*

**Weathered  
Timber**



**Antique  
Slate**



**Charcoal**



**Barkwood**



**PREMIUM COLOR BLEND** \*\*

**Royal  
Slate**



# GRAND SEQUOIA®

LIFETIME *Designer* SHINGLES

Great Value For A Rugged  
Wood-Shake Look



U.S. only

\*StainGuard® protection applies only to shingles with StainGuard-labeled packaging. See *GAF Shingle & Accessory Ltd. Warranty* for complete coverage and restrictions.

\*\*Uses premium color shingle granules in an exclusively formulated color blend.



# SLATELINE®

LIFETIME *Designer* SHINGLES

The Look Of Slate...  
At A Fraction Of The Cost



U.S. only

\*See *GAF Shingle & Accessory Ltd. Warranty* for complete coverage and restrictions.

\*\*Uses premium color shingle granules in an exclusively formulated color blend.

This product is not available in all areas. See [gaf.com](http://gaf.com) for availability and details.

*Note: It is difficult to reproduce the color clarity and actual color blends of these products. Before selecting your color, please ask to see several full-size shingles.*

LIFETIME DESIGNER SHINGLES — VALUE COLLECTION



Color Shown:  
**Cedar**

 <p><b>Cedar</b></p>	 <p><b>Charcoal</b></p>	 <p><b>Mesa Brown</b></p>	 <p><b>Weathered Wood</b> <small>(Only available in the Southwest &amp; West Areas)</small></p>	 <p><b>Autumn Brown</b></p>	 <p><b>Slate</b></p>	<p><b>PREMIUM COLOR BLEND</b> **</p>  <p><b>Weathered Timber</b> <small>(Only available in the Northeast, Southeast and Central Areas)</small></p>
---	--	--	---	--	--	---



Color Shown:  
**Emerald Green**

<p><b>PREMIUM COLOR BLEND</b> **</p>  <p><b>Royal Slate</b></p>	 <p><b>Antique Slate</b> <small>(less contrast than English Gray)</small></p>	 <p><b>Emerald Green</b></p>	 <p><b>English Gray</b> <small>(more contrast than Antique Slate)</small></p>	 <p><b>Weathered Slate</b></p>
--	--	---	---	---



# GRAND SEQUOIA<sup>®</sup> ARMOR SHIELD<sup>™</sup>

SBS Modified IR Shingles



U.S. only

\*See GAF Shingle & Accessory Ltd. Warranty for complete coverage and restrictions.



# TIMBERLINE<sup>®</sup> ARMORSHIELD<sup>™</sup> II

SBS Modified IR Shingles



U.S. only

\*See GAF Shingle & Accessory Ltd. Warranty for complete coverage and restrictions.

*Note: It is difficult to reproduce the color clarity and actual color blends of these products. Before selecting your color, please ask to see several full-size shingles.*

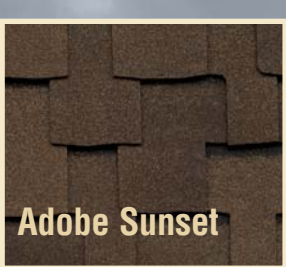
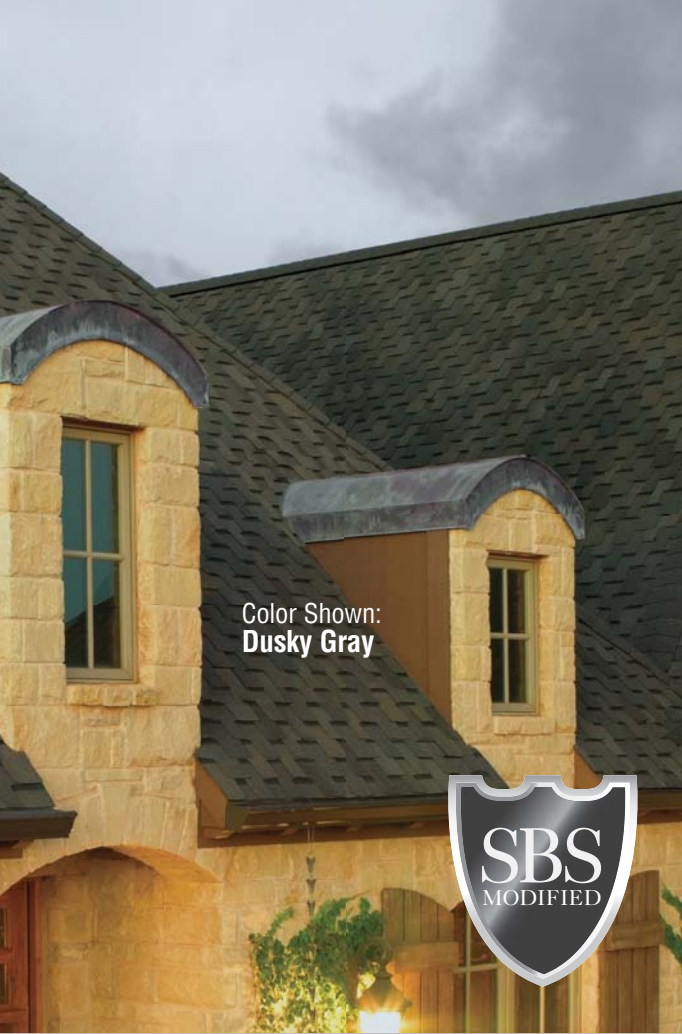

# SBS MODIFIED IR SHINGLES

## Get Extra Protection For Your Most Valuable Asset!

- Potential Insurance Savings... Shingles pass the UL 2218 Class 4 Impact-Resistance Test, and may qualify for insurance discounts<sup>1</sup>
- Exceptional Protection... Design includes an SBS modified asphalt formula for rubber-like flexibility and increased impact resistance
- Excellent Wind Performance... Shingles are warranted to withstand maximum wind gusts of up to 130 mph (209 km/h)<sup>2</sup>
- Peace Of Mind... Lifetime ltd. transferable warranty with Smart Choice<sup>®</sup> Protection (non-prorated material and installation coverage) for the first ten years<sup>3</sup>
- Ridge Cap Shingles... Use our Seal-A-Ridge<sup>®</sup> ArmorShield<sup>™</sup> SBS Modified IR Ridge Cap Shingles. They're a unique color match to GAF ArmorShield<sup>™</sup> Series Shingles

<sup>1</sup> Insurance discounts may not be available in your area. Where available, insurance discounts may vary. Contact your insurance provider for information.  
<sup>2</sup> This wind coverage requires special installation; see GAF Shingle & Accessory Ltd. Warranty for details.  
<sup>3</sup> See GAF Shingle & Accessory Ltd. Warranty for complete coverage and restrictions. The word "lifetime" refers to the length of coverage provided by the GAF Shingle & Accessory Ltd. Warranty and means as long as the original individual owner(s) of a single-family detached residence [or the second owner(s) in certain circumstances] owns the property where the shingles are installed. For owners/structures not meeting the above criteria, Lifetime coverage is not applicable.

Note: Always use complementary-color GAF StarterMatch<sup>™</sup> Starter Strip Shingles when installing Grand Sequoia<sup>®</sup> ArmorShield<sup>™</sup> SBS Modified IR Shingles for the best look.

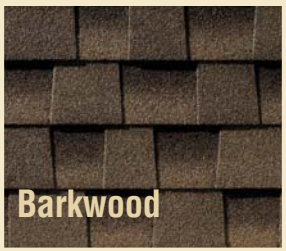
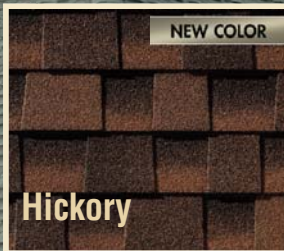

### Where They Fit Within The Lifetime Roofing System

#### 1. Lifetime Shingles

2. Leak Barrier
3. Starter Strip Shingles
4. Roof Deck Protection
5. Cobra<sup>®</sup> Attic Ventilation
6. Ridge Cap Shingles

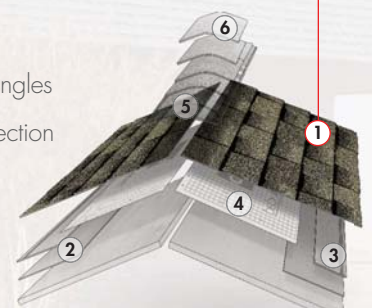



# Ridge Cap Shingles

Installed on the hip and ridge areas of a home to help provide maximum protection

- Accentuate the Natural Beauty... Of your newly installed shingle roof
- Protect... Guard against leaks and blow-offs at the hip and ridge areas of your roof
- The Right Colors... Designed to complement the color of your roof's shingles (unlike cut-up 3-tab shingles)
- Peace Of Mind... Up to a Lifetime Ltd. warranty when installed on Lifetime Shingle roofs<sup>1</sup>



U.S. only

<sup>1</sup> See GAF Shingle & Accessory Ltd. Warranty for complete coverage and restrictions. The word "Lifetime" refers to the length of coverage provided by the GAF Shingle & Accessory Ltd. Warranty and means as long as the original individual owner(s) of a single-family detached residence [or the second owner(s) in certain circumstances] owns the property where the shingles and accessories are installed. For owners/structures not meeting the above criteria, Lifetime coverage is not applicable. Lifetime Ltd. warranty on accessories requires the use of at least three qualifying GAF accessories and the use of Lifetime Shingles.

<sup>2</sup> Periodically tested by independent and internal labs to ensure compliance with ASTM D3462 at time of manufacture.

<sup>3</sup> See GAF Shingle & Accessory Ltd. Warranty for complete coverage and restrictions.

These products are not available in all areas. See [www.gaf.com/ridgecapavailability](http://www.gaf.com/ridgecapavailability) for details.

## Where They Fit Within The Lifetime Roofing System

1. Lifetime Shingles
2. Leak Barrier
3. Starter Strip Shingles
4. Roof Deck Protection
5. Cobra® Attic Ventilation
6. Ridge Cap Shingles

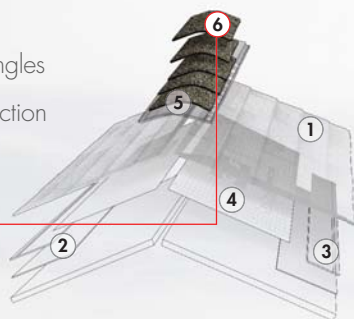

## TIMBERTEX®

### Premium Ridge Cap Shingles

#### SPECIFICATIONS

- Fiberglass asphalt design with double-layer construction
- Available in 12" (305 mm) width
- 8" (203 mm) exposure
- UL Listed to ANSI/UL 790 Class A
- Meets ASTM D3161 Class F; ASTM D3018 Type I; and ASTM D3462<sup>2</sup>
- Miami-Dade County Product Control approved
- CSA A123.5
- Florida Building Code approved
- ICC-ES ESR-1475 and ICC-ES ESR-3267
- 150 pieces per 100 lineal ft. (30 lm); 5 bundles per 100 lineal ft. (30 lm)
- Approx. 2 nails per piece
- Up to a Lifetime Ltd. warranty when installed on Lifetime Shingle roofs<sup>1</sup>





## RIDGLASS®

### Premium Ridge Cap Shingles

#### SPECIFICATIONS

- Fiberglass SBS polymer-modified asphalt design
- Available in 8" (203 mm) and 10" (254 mm) widths
- 8" (203 mm) exposure
- Meets ASTM D3161 Class A; ASTM D3018 Type I; and ASTM D3462<sup>2</sup>
- UL Listed to ANSI/UL 790 Class A
- CSA A123.5
- ICC-ES ESR-1475 and ICC-ES ESR-3267
- 48 (8" [203 mm] & 10" [254 mm]) pcs./box (one box covers 31 lineal ft. [9 lm] of finished hip & ridge); 3.2 boxes cover approx. 100 lineal ft. (30 lm)
- Approx. 2 nails per piece
- Up to a Lifetime ltd. warranty when installed on Lifetime Shingle roofs<sup>1</sup>



## SEAL-A-RIDGE®

### Protective Ridge Cap Shingles

#### SPECIFICATIONS

(Standard Seal-A-Ridge® Ridge Cap Shingles)

- Fiberglass asphalt design
- 6 2/3" (169 mm) exposure
- Approx. 12" (305 mm) wide
- UL Listed to ANSI/UL 790 Class A
- Miami-Dade County Product Control approved
- Florida Building Code approved
- Meets ASTM D3462<sup>2</sup>
- ICC-ES ESR-1475 and ICC-ES ESR-3267
- 4 bundles cover approx. 100 lineal feet (30 lm)
- Approx. 2 nails per piece
- Up to a Lifetime ltd. warranty when installed on Lifetime Shingle roofs<sup>1</sup>

#### SPECIFICATIONS

(Seal-A-Ridge® ArmorShield™ SBS Modified IR Ridge Cap Shingles)

- Fiberglass SBS modified asphalt design
- UL 2218 Class 4 impact resistant
- 5" (127 mm) exposure
- Approx. 12" (305 mm) wide
- UL Listed to ANSI/UL 790 Class A
- Meets ASTM D3462<sup>2</sup>
- ICC-ES ESR-1475 and ICC-ES ESR-3267
- 4 bundles cover approx. 100 lineal feet (30 lm)
- Approx. 2 nails per piece
- Up to a Lifetime ltd. warranty when installed on Lifetime Shingle roofs<sup>1</sup>



## Z-RIDGE®

### Distinctive Ridge Cap Shingles

#### SPECIFICATIONS

- Fiberglass asphalt design
- 5 5/8" (143 mm) exposure
- Approx. 10" (254 mm) wide
- UL Listed to ANSI/UL 790 Class A
- Meets ASTM D3018 Type I, ASTM D3161 Class A, and ASTM D3462<sup>2</sup>
- ICC-ES ESR-1475 and ICC-ES ESR-3267
- 3 bundles cover approx. 100 lineal feet (30 lm)
- Up to a Lifetime ltd. warranty when installed on Lifetime Shingle roofs<sup>1</sup>

Only available in the U.S.

<sup>1,2,3</sup> See footnotes on previous page





# Roof Deck Protection

Helps guard against wind-driven rain and keep your roof system dry

- **An Extra Layer of Protection...** Between your shingles and your roof deck
- **Helps Prevent Wind-Driven Rain...** (Or water from other sources) from infiltrating under your shingles and causing damage to your roof structure or the inside of your home
- **Lies Flatter...** Helps avoid buckling when installed for a better-looking finished roof
- **Helps Reduce Blow-off...** By allowing your shingles to lie flatter and more uniformly
- **Peace of Mind...** Up to a Lifetime Ltd. warranty when installed on Lifetime Shingle roofs†



U.S. only

† See GAF Shingle & Accessory Ltd. Warranty for complete coverage and restrictions. The word "Lifetime" refers to the length of coverage provided by the GAF Shingle & Accessory Ltd. Warranty and means as long as the original individual owner(s) of a single-family detached residence [or the second owner(s) in certain circumstances] owns the property where the shingles and accessories are installed. For owners/structures not meeting the above criteria, Lifetime coverage is not applicable. Lifetime Ltd. warranty on accessories requires the use of at least three qualifying GAF accessories and the use of Lifetime Shingles.

## Where They Fit Within The Lifetime Roofing System

1. Lifetime Shingles
2. Leak Barrier
3. Starter Strip Shingles
4. **Roof Deck Protection**
5. Cobra® Attic Ventilation
6. Ridge Cap Shingles

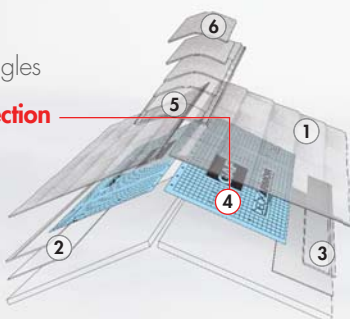

# DECKARMOR™

Premium **Breathable** Roof Deck Protection



- **Revolutionary "Breathable" Technology...** Helps reduce moisture in the roofing system that can cause mold, mildew, and expensive structural damage
- **Enhanced Walkability...** Specially designed surface helps provide enhanced walkability for installers compared to conventional felts or typical synthetic underlayments
- **Premium Construction...** Exceptionally durable, non-asphaltic construction will not rot or become brittle (unlike conventional asphaltic felts, which can disintegrate over time)
- **Exceptionally Strong...** At least 600% greater tear strength than standard #30 felt<sup>1</sup>
- **Looks Better...** Unlike conventional asphaltic felts, Deck-Armor™ resists wrinkling or buckling, so it lets your shingles lie flatter for a better-looking roof

<sup>1</sup> GAF trapezoidal tear strength (lbs) testing per ASTM D4533.

## SPECIFICATIONS

- UV-stabilized polypropylene construction resists UV degradation for up to 180 days\*
- Meets or exceeds the physical requirements of ASTM D226 and D4869
- Miami-Dade County Product Control and Florida Building Code approved
- ICC-ES ESR-2808
- Approx: 10 squares (1,000 ft<sup>2</sup> [92.9 m<sup>2</sup>])/roll (excludes laps); length 223' (68 m); width 54" (1.4 m); 37 lb. (17 kg)/roll (nominal)
- Listed with Texas Department of Insurance as an acceptable alternate roof underlayment

Note: **Always** use plastic cap nails or staples with plastic caps to install Deck-Armor™ Roof Deck Protection. Do **NOT** use nails or staples without caps.

## Deck-Armor™ "Out-breathes" the competition!



As measured on Mocon unit @ 23°C and 50% R.H. by GAF



# SHINGLE-MATE®

Roof Deck Protection

- Fiberglass reinforced, so it lies flatter than typical asphalt felts for a better-looking roof
- UL Listed to ANSI/UL 790 Class A when used with UL Class A roof coverings
- Miami-Dade County Product Control and Florida Building Code approved
- Meets the physical requirements of ASTM D226 and ASTM D4869
- Approx: 4 squares/roll (432 ft<sup>2</sup> [40.13 m<sup>2</sup>]); length 144' (43.89 m); width 36" (914 mm); 30 lb. (13.6 kg)/roll

\* See footnote on next page

# TIGERPAW™

Roof Deck Protection



- **Excellent Walkability...** Specially designed surface helps provide excellent walkability for installers compared to conventional felts or typical synthetic underlayments
- **Moisture-Control Design...** Helps remove nearly twice as much damaging moisture from your roof deck as the leading synthetic non-breathable underlayment<sup>1</sup>
- **Durable Construction...** Non-asphaltic, polypropylene construction will not rot or become brittle (unlike conventional felts, which can disintegrate over time)
- **Better-Looking Roof...** Unlike conventional asphaltic felts, Tiger Paw™ Roof Deck Protection resists wrinkling and buckling that can “telegraph” through your roof shingles and detract from its finished appearance
- **Stronger...** Synthetic, non-woven construction provides at least 600% greater tear strength than standard #30 felt<sup>2</sup>

<sup>1</sup> As per GAF ASTM D570-modified testing.  
<sup>2</sup> GAF trapezoidal tear strength (lbs) testing per ASTM D4533.

## SPECIFICATIONS

- UV-stabilized polypropylene construction resists UV degradation for up to 180 days\*
- Meets or exceeds the physical requirements of ASTM D226, D4869, and CSA A220-1
- Miami-Dade County Product Control and Florida Building Code approved
- ICC-ES ESR-3286
- Approx: 10 squares (1,000 ft<sup>2</sup> [92.9 m<sup>2</sup>])/roll (excludes laps); length 250' (76.2 m); width 48" (1.22 m); 40 lb. (18 kg)/roll (nominal)
- Listed with Texas Department of Insurance as an acceptable alternate roof underlayment

Note: **Always** use plastic cap nails or staples with plastic caps to install Tiger Paw™ Roof Deck Protection. Do **NOT** use nails or staples without caps.

\*Note: 180-day UV resistance refers to standardized testing conducted by GAF to ensure the product will not physically degrade when exposed to UV. It is **NOT** related to withstanding water, snow, or wind. While Deck-Armor™ and Tiger Paw™ Roof Deck Protection are water resistant, they are **NOT WATERPROOF. DO NOT USE** Deck-Armor™ or Tiger Paw™ Roof Deck Protection as a temporary roof to protect property or possessions.

# FELTBUSTER®

HIGH-TRACTION SYNTHETIC ROOFING FELT



- **Enhanced Walkability...** Special spunbound surface helps provide increased traction compared to typical asphalt felts
- **Tough Synthetic Construction...** Resists tearing and will not absorb moisture, become brittle, or leach oils
- **Easy to Work With...** Super-lightweight, 10 square, 48" (1.23 m) wide roll (vs. typical 36" [914 mm] wide felt rolls)
- **Cooler to Work On...** Medium-gray surface is cooler than typical black asphalt felts and the leading black low-cost synthetic underlayment

## SPECIFICATIONS

- UV-stabilized polypropylene construction resists UV degradation for up to 90 days\*\*
- For use with asphalt shingles
- Meets or exceeds the physical requirements of ASTM D226, D4869, and CSA A123-3
- Miami-Dade County Product Control and Florida Building Code approved
- Approx: 10 squares/roll – 1,000 sq. ft. (92.9 m<sup>2</sup>) (excludes laps); length 250' (76.2 m); width 48" (1.22 m); 23 lb. (10.4 kg) / roll (nominal)
- Listed with Texas Department of Insurance as an acceptable alternate roof underlayment

Note: **Always** install FeltBuster® High-Traction Synthetic Roofing Felt using plastic cap nails or plastic cap staples. Do **NOT** use nails or staples without caps.

\*\*Note: 90-day UV resistance refers to standardized testing conducted by GAF to ensure the product will not physically degrade when exposed to UV. It is **NOT** related to withstanding water, snow, or wind. While FeltBuster® High-Traction Synthetic Roofing Felt is water resistant, it is **NOT WATERPROOF. DO NOT USE** FeltBuster® High-Traction Synthetic Roofing Felt as a temporary roof to protect property or possessions.



# VERSASHIELD®

FIRE-RESISTANT ROOF DECK PROTECTION

(Available across the U.S.; not available in Canada)

- The best protection against fire spread and penetration
- Fiberglass reinforced, so it lies flatter than typical asphalt felts for a better-looking roof
- Will upgrade the UL fire classification of almost any type of roof (refer to UL Certifications Directory for actual assemblies)
- Meets or exceeds ASTM D226 Type II, D4869 Type IV, and D6757 Type I or Type II
- Approx: 3.5 squares/roll (350 ft<sup>2</sup> [32.5 m<sup>2</sup>]) (excludes laps); length 100' (30.5 m); width 42" (1,067 mm); 52.5 lb. (24 kg)/roll
- Miami-Dade County Product Control and Florida Building Code approved
- ICC-ES ESR-2053
- Listed with Texas Department of Insurance as an acceptable alternate roof underlayment



# ROOFPRO™

SBS-Modified All-Purpose Underlayment

(Available in Western U.S. only)

- SBS-modified asphalt increases flexibility and provides long-lasting durability; up to 60 days' UV exposure resistance\*\*\*
- Fiberglass reinforced, so it lies flatter than typical asphalt felts for a better-looking roof
- UL Listed to ANSI/UL 790 Class A when used with UL Class A roof coverings
- Meets or exceeds all physical properties of ASTM D226
- UL ER10689-01 Evaluation Report
- Approx: 2 squares/roll (216 gross ft<sup>2</sup> [20.1 m<sup>2</sup>]); length 65.8' (20.1 m); width 39.4" (1 m)

\*\*\*Note: 60-day UV resistance refers to standardized testing conducted by GAF to ensure the product will not physically degrade when exposed to UV. It is **NOT** related to withstanding water, snow, or wind. While RoofPro™ SBS-Modified All-Purpose Underlayment is water resistant, it is **NOT WATERPROOF. DO NOT USE** RoofPro™ SBS-Modified All-Purpose Underlayment as a temporary roof to protect property or possessions.



# Leak Barriers

Provides exceptional protection against leaks caused by roof settling and extreme weather

- **Protect Your Property...** Help prevent wind-driven rain from leaking through the roof deck, or melting ice and snow (caused by ice dams in harsh winter climates) from leaking into property's interior
- **Add Extra Protection...** In valleys and at eave and rake edges—the most leak-prone areas of the roof. Strongly recommended for other areas like skylights, dormers, vent pipes, chimneys, and other flashing areas
- **Help Avoid Costly Repairs...** Due to staining on interior walls and ceilings from leaks
- **Peace Of Mind...** Up to a Lifetime Ltd. warranty when installed on Lifetime Shingle roofs†



U.S. only

† See GAF Shingle & Accessory Ltd. Warranty for complete coverage and restrictions. The word "Lifetime" refers to the length of coverage provided by the GAF Shingle & Accessory Ltd. Warranty and means as long as the original individual owner(s) of a single-family detached residence [or the second owner(s) in certain circumstances] owns the property where the shingles and accessories are installed. For owners/structures not meeting the above criteria, Lifetime coverage is not applicable. Lifetime Ltd. warranty on accessories requires the use of at least three qualifying GAF accessories and the use of Lifetime Shingles.

## Where They Fit Within The Lifetime Roofing System

1. Lifetime Shingles
2. **Leak Barrier**
3. Starter Strip Shingles
4. Roof Deck Protection
5. Cobra® Attic Ventilation
6. Ridge Cap Shingles

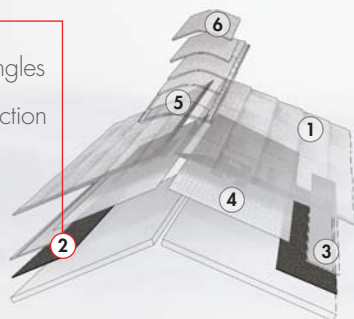

## "Protect Your Investment And Safeguard Vulnerable Areas"

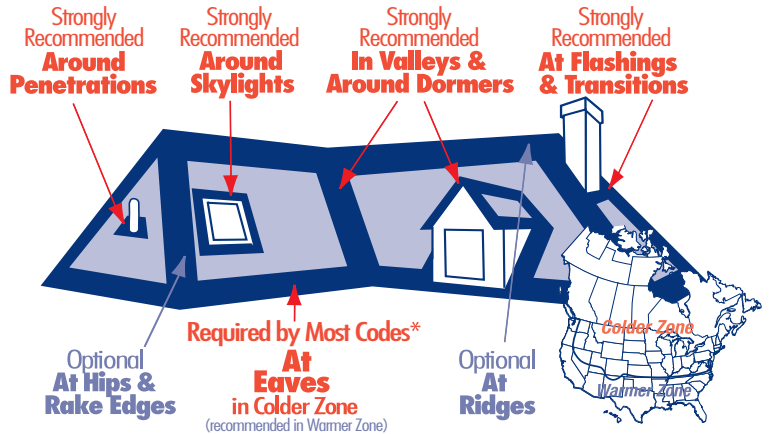

\*Check local building codes for specifications in your area.



## SPECIFICATIONS (NOM.)

### WEATHERWATCH® Mineral-Surfaced Leak Barrier

(For Shingle Roofs)

- Mineral surface & fiberglass reinforced
- Split-back release film
- UL Listed to ANSI/UL 790 Class A
- ICC Evaluation Report ESR-1322
- Meets the performance criteria of ASTM D1970
- Miami-Dade County Product Control approved
- State of Florida approved
- Roll width is 36" (0.9 m)
- Available in 1.5 & 2.0 square rolls
- Length of 1.5 square roll is 50' (15.2 m)
- Length of 2.0 square roll is 66.8' (20.3 m)
- Approx. area of 1.5 square roll is 150 ft<sup>2</sup> (13.9 sq m)
- Approx. area of 2.0 square roll is 200 ft<sup>2</sup> (18.6 sq m)

### STORMGUARD® Film-Surfaced Leak Barrier

(For Shingle And Metal Roofs)

- Film surface & fiberglass reinforced
- Split-back release film
- UL Listed to ANSI/UL 790 Class A
- ICC Evaluation Report ESR-1322
- Meets the performance criteria of ASTM D1970
- Miami-Dade County Product Control approved
- State of Florida approved
- Available in 2.0 square rolls
- Width is 36" (0.9 m), length is 66.8' (20.3 m)
- Approx. area of 2.0 square roll is 200 ft<sup>2</sup> (18.6 sq m)



# Eave/Rake Starter Strips

Help prevent shingle blow-off and reduce waste

- Placed at the eaves... To help prevent shingle blow-off
- Save Labor... Provides a cost-effective alternative to using cut-up shingles as your starter strip
- Help Prevent Blow-Offs... Includes a high-quality, properly positioned factory-applied adhesive that will tightly lock your shingles in place
- Easy To Install... Pre-scored (Pro-Start® & WeatherBlocker™ only); no cutting needed
- Maximum Wind Warranties... Requires starter strips on rake and eaves†
- Peace Of Mind... Up to a Lifetime Ltd. warranty when installed on Lifetime Shingle roofs†



\* Periodically tested by independent and internal labs to ensure compliance with ASTM D3462 at time of manufacture.

† See GAF Shingle & Accessory Ltd. Warranty for complete coverage and restrictions. The word "Lifetime" refers to the length of coverage provided by the GAF Shingle & Accessory Ltd. Warranty and means as long as the original individual owner(s) of a single-family detached residence (or the second owner(s) in certain circumstances) owns the property where the shingles and accessories are installed. For owners/structures not meeting the above criteria, Lifetime coverage is not applicable. Lifetime Ltd. warranty on accessories requires the use of at least three qualifying GAF accessories and the use of Lifetime Shingles.

## Where They Fit Within The Lifetime Roofing System

1. Lifetime Shingles
2. Leak Barrier
3. Starter Strip Shingles
4. Roof Deck Protection
5. Cobra® Attic Ventilation
6. Ridge Cap Shingles

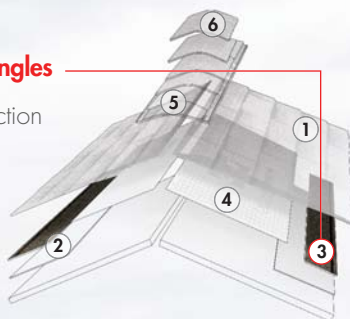

! Many warranties require starter strips on both eave and rake for maximum wind coverage

## WEATHERBLOCKER™ PREMIUM EAVE/RAKE STARTER STRIP

(Use with all shingles. 17"x40" [432 x 1,016 mm] or splits to 8.5"x40" [216 x 1,016 mm])

- Meets ASTM D3462\*
- UL Listed to ANSI/UL 790 Class A
- Available nationally
- Miami Dade County Product Control and Florida Building Code approved



## PRO-START® EAVE/RAKE STARTER STRIP SHINGLES

(Use with most standard English and metric-sized shingles. 13"x38" [330 x 965 mm] or splits to 6.5"x38" [165 x 965 mm])

- Meets ASTM D3462\*
- UL Listed to ANSI/UL 790 Class A
- Available nationally
- Miami Dade County Product Control and Florida Building Code approved

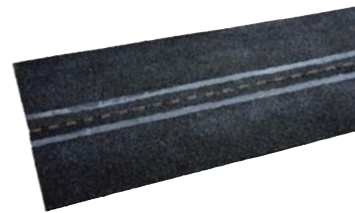

## QUICKSTART® Peel & Stick Starter Roll

(Peel & Stick installation helps eliminate fastening and cutting of starters. For shingles with 6" [152 mm] or less exposure. 9' x 33' [227 mm x 10 m] roll.)

- Available nationally
- Florida Building Code approved
- Meets physical property requirements of ASTM D1970



Also Available:

## STARTERMATCH™ STARTER STRIP SHINGLES

(Designed for use with GAF Lifetime Designer Shingles requiring complementary color starter. 13.25" x 40" [337 mm x 1,016 mm])



# Cobra® Attic Ventilation

Helps to remove excess heat and moisture to protect your roof system and structure from premature deterioration

- Looks Terrific... Shingle-over design helps maintain an "uncluttered" look on your roof
- Promotes Energy Efficiency... By helping reduce excessive heat in your attic
- Durable Construction... Manufactured with tough, UV-stable materials for performance in virtually any climate
- Strong... Passes the 110 mph (177 km/h) wind-driven rain test (under controlled GAF laboratory testing)
- Peace of Mind... Up to a Lifetime Ltd. warranty when installed on Lifetime Shingle roofs†



U.S. only

† See GAF Shingle & Accessory Ltd. Warranty for complete coverage and restrictions. The word "Lifetime" refers to the length of coverage provided by the GAF Shingle & Accessory Ltd. Warranty and means as long as the original individual owner(s) of a single-family detached residence [or the second owner(s) in certain circumstances] owns the property where the shingles and accessories are installed. For owners/structures not meeting the above criteria, Lifetime coverage is not applicable. Lifetime Ltd. warranty on accessories requires the use of at least three qualifying GAF accessories and the use of Lifetime Shingles.

## Where They Fit Within The Lifetime Roofing System

1. Lifetime Shingles
2. Leak Barrier
3. Starter Strip Shingles
4. Roof Deck Protection
5. **Cobra® Attic Ventilation**
6. Ridge Cap Shingles

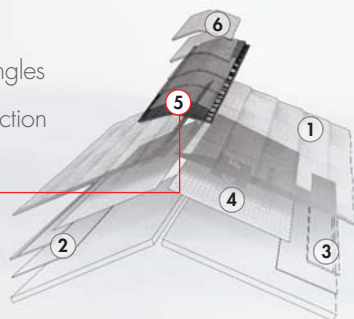

## Choose From The Industry's

### 5 Styles To Choose From!



<b>Product Name</b>	<b>Cobra® Exhaust Vent for Roof Ridge</b>
<b>Description &amp; Availability</b>	Roll-style vent, available in all climates
<b>Net Free Ventilating Area (NFVA)</b>	16.9 in <sup>2</sup> (109 cm <sup>2</sup> ) (hand nail version) 14.1 in <sup>2</sup> (91 cm <sup>2</sup> ) (nail gun version)
<b>Width(s) Available</b>	8" (203 mm) & 10.5" (267 mm); 11.75" (299 mm) metric
<b>Nail-Gunable</b>	Yes (nail gun version)
<b>Length</b>	20' (6.1 m) & 50' (15.24 m) rolls
<b>Nails Included?</b>	Yes
<b>Hand Tearable?</b>	No
<b>Weather Filter?</b>	N/A

## Cobra® Ridge Vents...

- Provide excellent attic ventilation when properly installed with intake vents
- Work along the length of the roof's ridge to minimize temperature and equalize pressure inside the attic
- Allow a flow-through of fresh air to reduce damaging heat and moisture
- Include the EasyTear™ Sizing Feature, which allows you to hand-tear the vents in regular increments (except Cobra® Exhaust Vent For Roof Ridge)
- Up to a Lifetime Ltd. warranty when installed on Lifetime Shingle roofs†
- Carry a UL Class C fire rating, except Cobra® Exhaust Vent For Roof Ridge, which has a UL Class A rating
- ICC Evaluation Report ESR-1265
- Miami-Dade County Product Control approved
- Evaluated by Texas Department of Insurance

# Most Comprehensive Line Of **Ridge Vents**!

	 (Only available in the U.S.)	 (Only available in the U.S.)	
<b>Cobra Ridge Runner® Exhaust Vent for Roof Ridge</b>	<b>Cobra® Rigid Vent 3™ Exhaust Vent for Roof Ridge</b>	<b>Cobra® Snow Country™ Exhaust Vent for Roof Ridge</b>	<b>Cobra® Snow Country Advanced™ Exhaust Vent for Roof Ridge</b>
Rigid roll-style vent, available in all climates	Premium rigid-style vent, available in warmer climates	Rigid-style vent, available in colder climates	Premium rigid-style vent, available in colder climates
12.5 in <sup>2</sup> (81 cm <sup>2</sup> )	18.0 in <sup>2</sup> (116 cm <sup>2</sup> )	18.0 in <sup>2</sup> (116 cm <sup>2</sup> )	18.0 in <sup>2</sup> (116 cm <sup>2</sup> )
11.5" (292 mm)	9" (229 mm) & 11.5" (292 mm)	11.5" (292 mm)	9" (229 mm) & 11.5" (292 mm)
Yes	No	No	No
20' roll (6.1 m)	4' sticks (1.21 m)	4' sticks (1.21 m)	4' sticks (1.21 m)
Yes	Yes	No	Yes
Yes	Yes	Yes	Yes
Yes	No	Yes	Yes

## Specialty Solutions...

### **Cobra® HIPVENT** Exhaust Vent for Hip Roofs

**Safe and effective attic exhaust ventilation  
for roofs with little or no ridge**

- Unique Dual-Weather Fighter Filter™ helps resist all types of weather infiltration\*
- Fully nail-gunable with included coil nails
- Size: 4' x 11.5" (1.21 m x 292.1 mm)
- NFA: 9 in<sup>2</sup> per lineal foot (58 cm<sup>2</sup>/lm)



Dual Weather Fighter Filter™

### **Cobra® INTAKEPRO** Rooftop Intake Vent

**Provides critical intake ventilation for homes  
with little or no soffits**

- Eliminates time consuming/expensive alterations at the soffit
- Fully nail-gunable with included coil nails
- Tested to resist wind-driven rain, snow and ice-dam infiltration\*
- Size: 20' x 11" (6.1 m x 279 mm)
- NFA: 9 in<sup>2</sup> per lineal foot (58 cm<sup>2</sup>/lm)

\*Under controlled GAF laboratory testing





# ROYAL SOVEREIGN®

## THREE-TAB SHINGLES

(Only available in the U.S.)



### Color Availability Chart

Ask your contractor which GAF plant supplies the Royal Sovereign® Shingles in your area.  
Or visit [gaf.com](http://gaf.com) for the most current color availability information for your area.

	Dallas, TX	Fontana, CA	Minneapolis, MN	Mobile, AL	Mt. Vernon, IN	Myerstown, PA	Pacific Northwest	Savannah, GA	Tampa, FL
<b>Most Popular Colors:</b>									
Autumn Brown	●		●	●	●	●		●	●
Charcoal	●	●	●	●	●	●	●	●	●
Golden Cedar	●		●	●	●	●		●	●
Silver Lining			●		●	●			●
Weathered Gray	●		●	●	●	●		●	●
White <sup>1,2</sup>		●	●		●	●			●
<b>Regional Colors:</b>									
Ash Brown	●								
Cypress Tan									●
Desert Sand <sup>2</sup>		●							
Nickel Gray			●		●	●			
Russet Red									●
Sandrift									●
Slate	●		●	●	●	●		●	
Summer Sage		●							

**Note:** It is difficult to reproduce the color clarity and actual color blends of these products. Before selecting your color, please ask to see several full-size shingles.

<sup>1,2</sup> See footnotes on next page

## Beauty And Performance Meet Affordability

- **Proven Quality...** Over 10 billion Royal Sovereign® Shingles have been installed in North America — enough to circle the Earth more than 200 times if they were laid end to end!
- **Advanced Protection® Shingle Technology...** Reduces the use of precious natural resources while providing excellent protection for your home (visit [gaf.com/APS/](http://gaf.com/APS/) to learn more).
- **Looks Great...** Color Lock™ Ceramic Firing (granules) helps maintain the true shingle color.
- **StainGuard® Protection...** Helps ensure the beauty of your roof against unsightly blue-green algae.\*
- **Stays In Place...** Passes the industry's two toughest wind tests: ASTM's 110 mph and 150 mph wind tests (under controlled laboratory conditions).
- **Excellent Performance...** Micro Weave™ Core offers a strong foundation that helps resist cracking and splitting.
- **Highest Roofing Fire Rating...** UL Class A, listed to ANSI/UL 790.
- **Great For Resale...** Long-lasting beauty may increase your home's resale value.
- **Peace Of Mind...** 25-year ltd. transferable warranty with Smart Choice® Protection (non-prorated material and installation labor coverage) for the first five years.\*\*



Color Shown:  
**Autumn Brown**

### Most Popular Colors



### Regional Colors



U.S. only



\* StainGuard® protection applies only to shingles with StainGuard®-labeled packaging. See GAF Shingle & Accessory Ltd. Warranty for complete coverage and restrictions.

\*\* See GAF Shingle & Accessory Ltd. Warranty for complete coverage and restrictions.

(Only available in the U.S. For information about Marquis WeatherMax® Three-tab Shingles, which are available in Canada, visit [gaf.ca](http://gaf.ca).)

<sup>1</sup> ENERGY STAR® certified (U.S. only). When installed properly, this product will help reduce energy costs. Actual savings will vary based on geographic location and individual building characteristics. For more information, contact GAF Technical Services at 1-800-ROOF-4111, visit [gaf.com](http://gaf.com), or call 1-888-STAR-YES.

<sup>2</sup> This shingle meets the prescriptive requirements of 2013 Title 24, Part 6, of the California Code of Regulations, is rated by the Cool Roof Rating Council (CRRCC), and meets the Los Angeles Green Building Code.





# Other Attic Ventilation & Specialty Products

- Master Flow® Ventilation Products
- Fiber-Cement Siding
- Accessory Paint
- Self-Adhering Low-Slope Roofing Systems



U.S. only. Excludes WeatherSide™ Fiber-Cement Siding

\* See Master Flow® Powered Ventilation Products Ltd. Warranty for complete coverage and restrictions.

\*\* See Master Flow® Ventilation Products Limited Warranty for complete coverage and restrictions. The word "Lifetime" refers to the length of coverage provided by the Master Flow® Ventilation Products Limited Warranty and means as long as you, the original owner(s) [or the second owner(s) if coverage was properly transferred] of the Master Flow® Ventilation Products, own the property where the Master Flow® Ventilation Products are installed on a single-family detached residence owned by individuals. For any other type of owner or building, such as a corporation, governmental entity, religious entity, condominium or homeowners association, school, apartment building, office building, or multi-use structure, the length of the warranty is 40 years.

† See Limited Warranty On Liberty™ SBS Materials for complete coverage and restrictions.

†† See System Pledge™ Roof Guarantee for complete coverage and restrictions.



## Power Attic Vents



Investing in a roof-mounted Master Flow® Power Attic Vent increases the overall comfort of your home, helps reduce the cost of air conditioning† and wear on the system, minimizes heat/moisture damage to roof and attic, and helps fight mold and mildew. Master Flow® Power Attic Vents feature:

- High-efficiency motors
- Large flashing for easy installation
- Automatic thermostat, available with humidistat/thermostat control as an option
- Complementary colors
- UL Listed to ANSI/UL 507



## Whole House Fans (Only available in the U.S.)

Master Flow® Whole House Fans help the property owner beat the heat and also help reduce air-conditioning costs† by forcing out hot air and bringing in cooler outside air.

- UL Listed to ANSI/UL 507
- Ceiling shutter included
- Backed with 5- or 10-year ltd. warranties\*



† Savings depend on various factors including, but not limited to, climate zone, utility rates, location, and HVAC equipment efficiency.

## Self-Adhering Low-Slope Roofing Systems

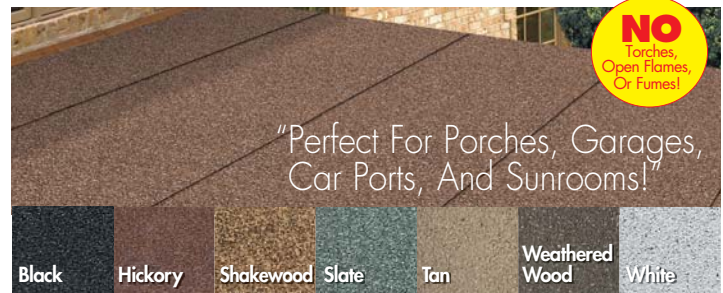

## LIBERTY™

SBS Self-Adhering Roofing System

- **Safer...** Self-adhering membrane system eliminates the need for open flames on the roof
- **No Fumes...** Unlike conventionally applied systems, eliminates the fumes and odors caused by hot asphalt or solvent-based adhesives
- **Proven Technology...** Based on the same technology used in GAF commercial roofing systems — proven in the field for decades!
- **Quicker Installation...** Often 1/3 faster than conventional systems, with minimal set-up or clean-up time
- **No Extra Tools...** No need to stage extra equipment
- **Limited Warranty Included...** against manufacturing defects†
- **Extended Guarantees Available...** Optional full-system guarantees against manufacturing defects and workmanship errors available for up to 20 years††
- **7 Popular Colors...** To complement your Timberline® Series or other residential shingle roof

Liberty™ SBS Self-Adhering Base/Ply Sheet

Liberty™ SBS Self-Adhering Cap Sheet

**Please Note:** These blended colors are designed to complement your shingles, not to be an exact match. Because of the small size of these samples, it is difficult to reproduce the actual color effect. Please be sure to see a full-size roll before making a final color selection.

# Master Flow® Ventilation Products

## Roof Louvers



(select models)

The Master Flow® line boasts one of the broadest assortments of roof louvers on the market today. Options include galvanized, aluminum, plastic, and unique granule-coated construction, as well as slant-back and square-top designs.



Unique granule-coated model

Master Flow® also offers a wide selection of “energy-free” ventilation products including soffit/undereave vents, aluminum ridge vents, wall louvers, chimney caps, foundation vents, and roof jacks to meet virtually every need.

## Wind Turbines



(select models)



The Master Flow® line offers the finest “energy free” attic ventilators. Dual-bearing turbines are:

- Backed by a Lifetime Ltd. warranty\*\*
- Internally or externally braced; 12" (305 mm) and 14" (357 mm) sizes
- Available in a large assortment of colors
- Miami-Dade County Product Control approved without storm caps! (select models)

## Solar-Powered Vents

The ultimate in energy-efficient power vents, Master Flow® Green Machine™ EcoSmart Solar Vents use the sun’s energy to remove damaging heat and moisture from your attic.

### PRSOLAR2 (Solar-Powered)

- 750 CFM airflow, includes h-stat/t-stat

### PRHYBRID2 (Dual-Powered)

- 750 CFM airflow on solar power, 900 CFM on house power; includes t-stat

### PRSOLAR1 (Solar-Powered)

- 500 CFM airflow

### PRHYBRID1 (Dual-Powered)

- 500 CFM airflow on solar power, 750 CFM on house power



- Equipped with brushless motors that require no maintenance
- 100% solar-powered models require no electrical wiring or electricians
- Unique dual-powered units run on house power at night or when the sun is not out and require 80% less electricity than conventional power vents (when running on house power)
- Miami-Dade County Product Control approved, State of Florida approved, and Texas Department of Insurance listed

## Roof Accessory Paint

# SHINGLE MATCH™

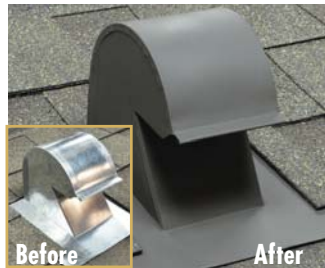

GAF ShingleMatch™ Roof Accessory Paint will help to hide unsightly protrusions on the roof, including vent pipes, exhaust vents, and flashings.

### PRODUCT SPECIFICATIONS

Can Size: 12 oz.  
Cans Per Case: 6  
Cases Per Pallet: 128

### COLORS:

Barkwood, Birchwood, Charcoal, Driftwood, Fox Hollow Gray, Hickory, Hunter Green, Mission Brown, Pewter Gray, Shakewood, Slate, and Weathered Wood



## Fiber-Cement Siding

# WeatherSide™

FIBER-CEMENT SIDING

“The One And Only Solution For Repairing Asbestos Siding”

- **Perfect Design...** Virtually identical in size and shape to millions of old non-existent asbestos siding shingles installed over the last 60 years
- **Avoid Hassles & Expenses...** Great for repairing or matching damaged asbestos siding shingles without the expense of new siding for the whole house
- **Safe...** WeatherSide™ Fiber-Cement Siding contains NO asbestos
- **Easy Installation...** After properly removing the old siding\*, simply nail the WeatherSide™ siding in place and paint
- **Pre-Primed...** Ready to be painted to match the existing wall color
- **Meets Code...** Miami-Dade County Product Control approved, State of Florida approved, UL Listed to ANSI/UL 723, and evaluated by Texas Department of Insurance



### Purity™ Shingle

- Textured surface with Straight, Wavy, or Thatched edge
- Size: 12" x 24" (305 mm x 609 mm)

### Profile Shingle

- Striated surface with straight edge
- Sizes: 9" x 32" (227 mm x 813 mm), 12" x 24" (305 mm x 609 mm), or 14 5/8" x 32" (371 mm x 813 mm)

### Emphasis™ Shingle

- Extra-thick wood grain surface with Thatched edge
- Size: 14 5/8" x 32" (371 mm x 813 mm)

### Matching Accessories Available...



- Siding Backer Strips (9" [227 mm], 12" [305 mm], and 14" [357 mm])



- Hot-dipped galvanized Siding Nails

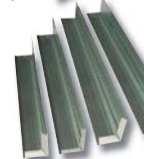

- Pre-Primed Individual Corners (9" [227 mm], 12" [305 mm], and 14" [357 mm], and Emphasis™ Corners)

\*We recommend that any removal and disposal of asbestos-containing products be done by a professionally trained asbestos removal contractor.

\*\* : † †† See footnotes on previous page



(U.S. only. Excludes Marquis WeatherMax® Shingles.)

**WARRANTY**

**APPROXIMATE PHYSICAL ATTRIBUTES**

					Pieces/Square	Bundles/Square	Neatly/Square <sup>6</sup>	Exposure	Dimensions
<b>LIFETIME DESIGNER SHINGLES SHINGLES ULTRA-PREMIUM COLLECTION</b>	<b>Camelot®</b>				56	7	280	7.5" 191 mm	17" x 34½" 432 x 876 mm
	<b>Glenwood®</b>				90	9	360	4.5" 114 mm	12¼" x 36½" 311 x 922 mm
	<b>Grand Canyon®</b>				72	6	360	5" 127 mm	17" x 40" 432 x 1016 mm
<b>LIFETIME DESIGNER SHINGLES VALUE COLLECTION</b>	<b>Grand Sequoia®</b>				70	5	360	5" 127 mm	17" x 40" 432 x 1016 mm
	<b>Woodland®</b>				56	4	280	6.5" 165 mm	17" x 40" 432 x 1016 mm
	<b>Monaco®</b>				48	3	240	7.5" 191 mm	17" x 40" 432 x 1016 mm
	<b>Camelot® II</b>				56	4	280	7.5" 191 mm	17" x 34½" 432 x 876 mm
	<b>Sienna®</b>				64	4	256	5.5" 140 mm	17¾" x 40" 441 x 1016 mm
	<b>Slateline®</b>				48	3	288	7.5" 191 mm	17" x 40" 432 x 1016 mm
<b>SBS MODIFIED IR SHINGLES</b>	<b>Timberline® ArmorShield™ II</b>				64	3	256	5½" 143 mm	13¼" x 39¾" 337 x 1000 mm
	<b>Grand Sequoia® ArmorShield™</b>				72	4	360	5" 127 mm	17" x 40" 432 x 1016 mm
<b>TIMBERLINE® LIFETIME SHINGLES</b>	<b>Timberline Ultra HD®</b>				64	4	256	5½" 143 mm	13¼" x 39¾" 337 x 1000 mm
	<b>Timberline® American Harvest®</b>				64	3	256	5½" 143 mm	13¼" x 39¾" 337 x 1000 mm
	<b>Timberline HD®</b>				64	3	256	5½" 143 mm	13¼" x 39¾" 337 x 1000 mm
	<b>Timberline® Natural Shadow®</b>				64	3	256	5½" 143 mm	13¼" x 39¾" 337 x 1000 mm
	<b>Timberline® Cool Series®</b>				64	3	256	5½" 143 mm	13¼" x 39¾" 337 x 1000 mm
<b>3-TAB SHINGLES</b>	<b>Royal Sovereign®</b>				79 Eng 64 Metric	3	316 Eng 256 Metric	5" Eng 127 mm 5½" Metric 143 mm	12" x 36" Eng 305 x 914 mm 13¼" x 39¾" Metric 337 x 1000 mm
	<b>Marquis WeatherMax®</b>				79	3	316	5" 127 mm	12" x 36" 305 x 914 mm

FIBERGLASS ASPHALT SHINGLE SPECIFICATIONS





# TruSlate

"THE AFFORDABLE GENUINE SLATE"®



TRUSLATE® GENUINE SLATE ROOFING

*Color shown:  
100% Charcoal  
Lighting Conditions:  
Bright sunlight*

*Note: Due to the inherent variability in the color of natural slate (as well as the limitations of the commercial printing process), the actual color and texture of your TruSlate® roof will vary from the photos depicted in this brochure.*



# Traditional Colors From North America's Finest Slate Quarries

- Genuine Hand-Split Quarried Slate... From North America's finest quarries – not a synthetic imitation
- Stunningly Beautiful... Helps differentiate your property and increases curb appeal
- Affordably Priced... Often comparable to the cost of a plastic imitation, tile, or metal
- Quality & Performance... Meets ASTM C406 S1-Grade and most building codes in the U.S.
- Lifetime Ltd. System Warranty\*... When installed by a GAF Certified SlateCrafter™ Specialist

### Specifications

- Slates meet ASTM C406, Grade S1
- Miami-Dade County Product Control approved
- State of Florida approved
- Evaluated by Texas Department of Insurance
- Code Compliance Research Report CCRR-0142
- FM 4473, Class 3 Impact Resistance

For the current specifications on TruSlate®, which is genuine slate (not an asphalt shingle), visit [gaf.com](http://gaf.com) or [truslate.com](http://truslate.com).



[truslate.com](http://truslate.com)



**Charcoal (U.S.)**



**Autumn Dusk (U.S.)**



**Onyx Black (Canada)**

\* See TruSlate® Smart Choice® Limited Warranty and TruSlate® Ultimate Pledge™ Limited Warranty for complete coverage and restrictions. The word "Lifetime" refers to the length of coverage provided by the TruSlate® Smart Choice® Limited Warranty and TruSlate® Ultimate Pledge™ Limited Warranty and means as long as the original individual owner(s) of a single-family detached residence (or the second owner(s) in certain circumstances) owns the property where the TruSlate® Premium Roofing System is installed. For owners/structures not meeting the above criteria, Lifetime coverage is not applicable.

Note: TruSlate® Slate is crafted from natural stone, so there may be variations in color between different slates or from one lot of slates to another. In addition, slate can fade or weather over time and each slate may fade or weather slightly differently, creating a natural mix of colors. For more information about weathering of each TruSlate® color, please see the TruSlate® brochure.

Note: TruSlate® genuine slate roofing is not part of the GAF Lifetime Roofing System.



# Exploring Shingle Styles and Colors

*with Nancy Fire*



**Nancy Fire, Co-Founder and Creative Director of Design Works International, has defined an exciting trend — taking the Inside Out.**

Nancy states, "As homeowners spend more time outside of their homes, they want to extend their interior style and sensibility — whether that be elegant, traditional, or more contemporary — to their outdoor living spaces that include the yard, the deck, and the roof.

"Your roof is a decision with a long-term impact. So make shingle, roofing style, and color choices that will complement your home and your personal style, providing you with years of comfort and satisfaction."





The color and style of your shingle are important! They go hand in hand when considering what shingle to use on your roof. After all, your roof represents up to 40% of your home's curb appeal, so it will always have a big impact on your home's overall look.

Choosing colors for your home's exterior is fun and exciting — and it's also a very significant decision. Remember, the color palette you select won't change with the seasons; it's going to be part of your home for the long term. So whether you like bolder colors that make a statement or you prefer more subtle, softer tones, you want to be sure that the palette you choose today is one that you'll still enjoy on your home years from now.

- Consider how much of your roof is visible from the street. Many times, larger roofs look more inviting using neutral tones while smaller roofs can be a bit more colorful, with more unique patterns.
- For a more traditional color palette, use tones of a color to incorporate a more subdued style into the exterior of your home. A neutral roof color creates the perfect backdrop for other colors.

- For a more contemporary design statement, try bringing attention to the top of your home (such as, using a red roof on a gray house) while coordinating trees and shrubs in the yard that will extend your roof color to your outdoor space (in this instance, like the Red Leaf Maple).

When it comes to choosing the style of your roof shingle, there's no such thing as right and wrong — there's only what works best for you and for your home. Certain elements, such as the size and pitch of your roof, can help determine what shingle style will better complement your home's exterior. Today, there are many types of shingle profiles and patterns available to help you differentiate your roof. Decide the statement you want to make, and embrace it!

- Color and texture add dimension to any home. In choosing your exterior shingle style, remember the importance of curb appeal in making these choices.

- The architectural style of your home is a key component when choosing a shingle style. A Colonial house, for example, might look best with a shingle that features a cleaner, more defined line, while a Victorian home could use a shingle with a more intense hue or a more elaborate and detailed design.

- A large roof surface is much like a blank canvas, giving you almost limitless possibilities for making a dramatic change in the look of your home's exterior. But smaller roofs or roofs with more variations in pitch also offer great opportunities, allowing the incorporation of more unique designs or patterns.

Above all, choose the shingle color and shingle style that make you feel the most comfortable. It's your home, your personality, your lifestyle. The final decision should reflect that — and do so beautifully!





There's  
a Style  
to fit your  
needs.  
There's  
a Color  
to fit your  
taste.





p10

p16

p10

p10

p10

p24

p16

p46

p46

p32

p46

p10

p20

p46

p32

p10

p18

p46

p10

p26

p10

p46

p20

p18

p32

p34

p24

p32

p10

p10

p46

p32

p30

p18

p10

p10

p28

p16

p24

p28

p16

p28

p34

p36

p24

p34

p30

p34

p36

p10

p30

p30

p32

p46

p36

p18

p34

p24

p26

p30

p10

p28

p34

p26

p28



A Long  
History of  
Innovation  
Has Made  
Us North  
America's  
Largest  
Roofing  
Manufacturer.

# 1886 Company Founded

- 1892**  
First to offer ready-to-lay asphalt roofing
- 1904**  
First to use colored granules in roofing materials
- 1912**  
First to introduce individually cut asphalt shingles
- 1933**  
Introduced first interlocking asphalt shingles
- 1967**  
Developed today's most popular laminated shingle: Timberline® Shingles

**1982**

First to introduce lighter weight high-performance asphalt shingles

**2003**

First to introduce self-adhered TPO membranes

**2005**

Introduced first energy-efficient asphalt shingle available in rich colors AND first capstocked composite decking product

**2010**

First to offer Advanced Protection® TPO membranes

**2012**

First to offer Lifetime ltd. warranty on entire GAF roofing system

**2016**

Introduced Timberline HD® Reflector Series™ Shingles, offering California homeowners a wider variety of rich color options to comply with Title 24 cool roof requirements

**1991**

Introduced first shingles with High Definition® technology

**2004**

Introduced first pre-coated energy-efficient modified bitumen membranes

**2007**

Introduced the first shingles with Advanced Protection® Technology—Timberline® Prestique® High Definition® Shingles

**2011**

First to offer Lifetime ltd. warranty on all laminated shingles

**2015**

Introduced Glenwood® Shingles, the industry's thickest triple-layer asphalt shingle



# MORE ROOFING PLANTS. MORE ROOFING PEOPLE.

**Sammy Sharp**  
Stillyard Leadman  
45 Years Of Service  
Dallas, TX



No matter where you live, there's a GAF plant that serves you, with products specially designed with you in mind. Made by hard-working men and women, many of whom are second- and third-generation employees who grew up with roofing "in their blood." They share our pride in innovation, and our commitment to investing in our country. In fact, GAF has more American plants than any other roofing manufacturer — along with the strongest network of factory-certified roofing contractors based in communities just like yours.